

Proposed Dwellings

Lot 7, 10 Fern Creek Road Warriewood

Landscape Development Application

DRAWINGS

DWG NO.	DRAWING TITLE	SCALE
007	COVER SHEET	N/A
107	LANDSCAPE PLAN - Lot 7	1:50
307	LANDSCAPE HARDSCAPE PLAN - Lot 7	1:50
407	LANDSCAPE PLANTING PLAN - Lot 7	1:50
507	LANDSCAPE SPECIFICATION & DETAILS - Lot 7	AS SHOWN

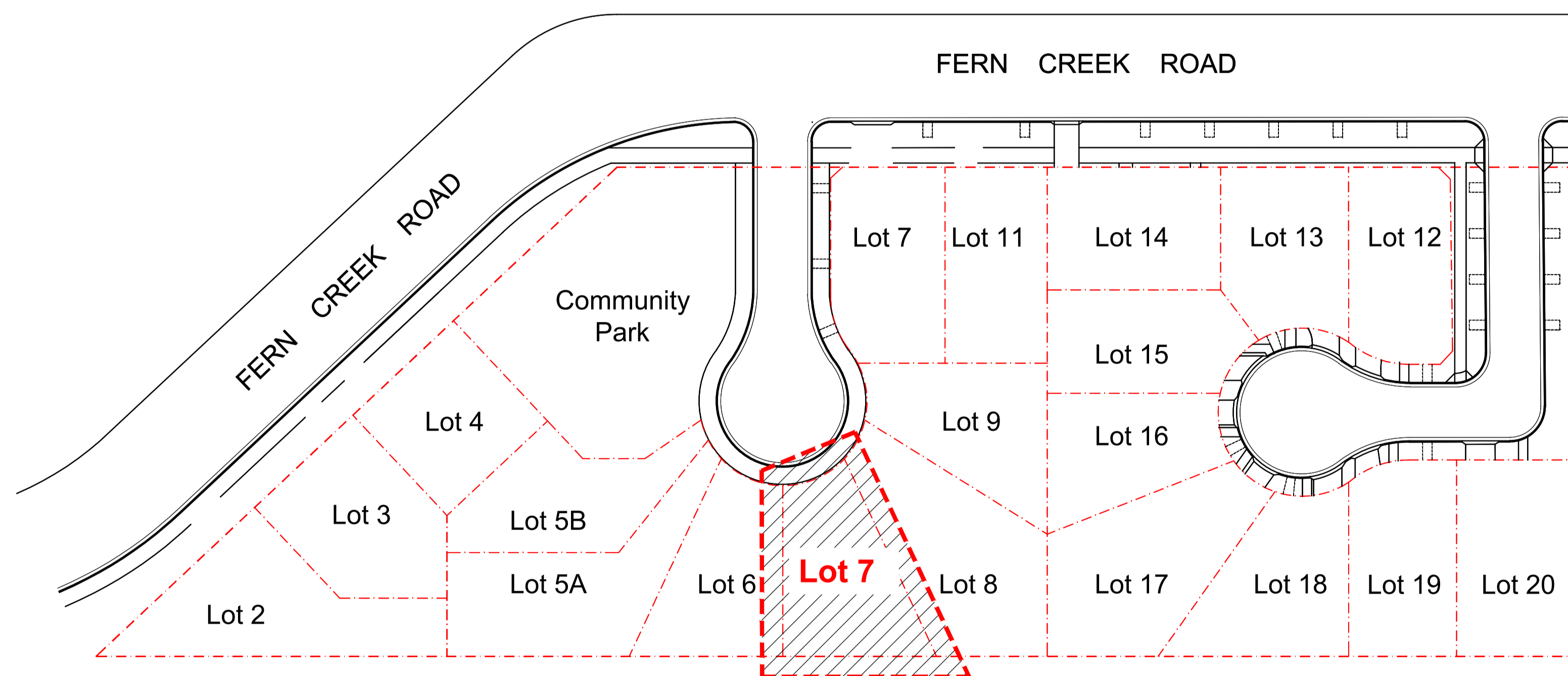

Key Plan | 1:500

NOT FOR CONSTRUCTION

© 2021 Site Image (NSW) Pty Ltd. ABN 44 801 262 380 as agent for Site Image NSW Partnership. All rights reserved. This drawing is copyright and shall not be reproduced or copied in any form or by any means (graphic, electronic or mechanical including photocopy) without the written permission of Site Image (NSW) Pty Ltd. Any license, expressed or implied, to use this document for any purpose whatsoever is restricted to the terms of the written agreement between Site Image (NSW) Pty Ltd and the instructing party.

The contractor shall check and verify all work on site (including work by others) before commencing the landscape installation. Any discrepancies are to be reported to the Project Manager or Landscape Architect prior to commencing work. Do not scale this drawing. Any required dimensions not shown shall be referred to the Landscape Architect for confirmation.

Legend

Key Plan

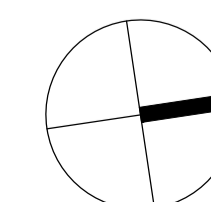

SITE IMAGE



Landscape Architects
Level 1, 3-5 Baptist Street
Redfern NSW 2016
Australia
Tel: (61 2) 8332 5600
Fax: (61 2) 9698 2877
www.siteimage.com.au

Client
SKYCORP AUSTRALIA

Project
Proposed Dwellings
10 Fern Creek Road
Warriewood

Drawing Name
Landscape Coversheet
- Lot 7

DEVELOPMENT APPLICATION

Scale
Job Number
Drawing Number
Issue

SS21-4780
007 A

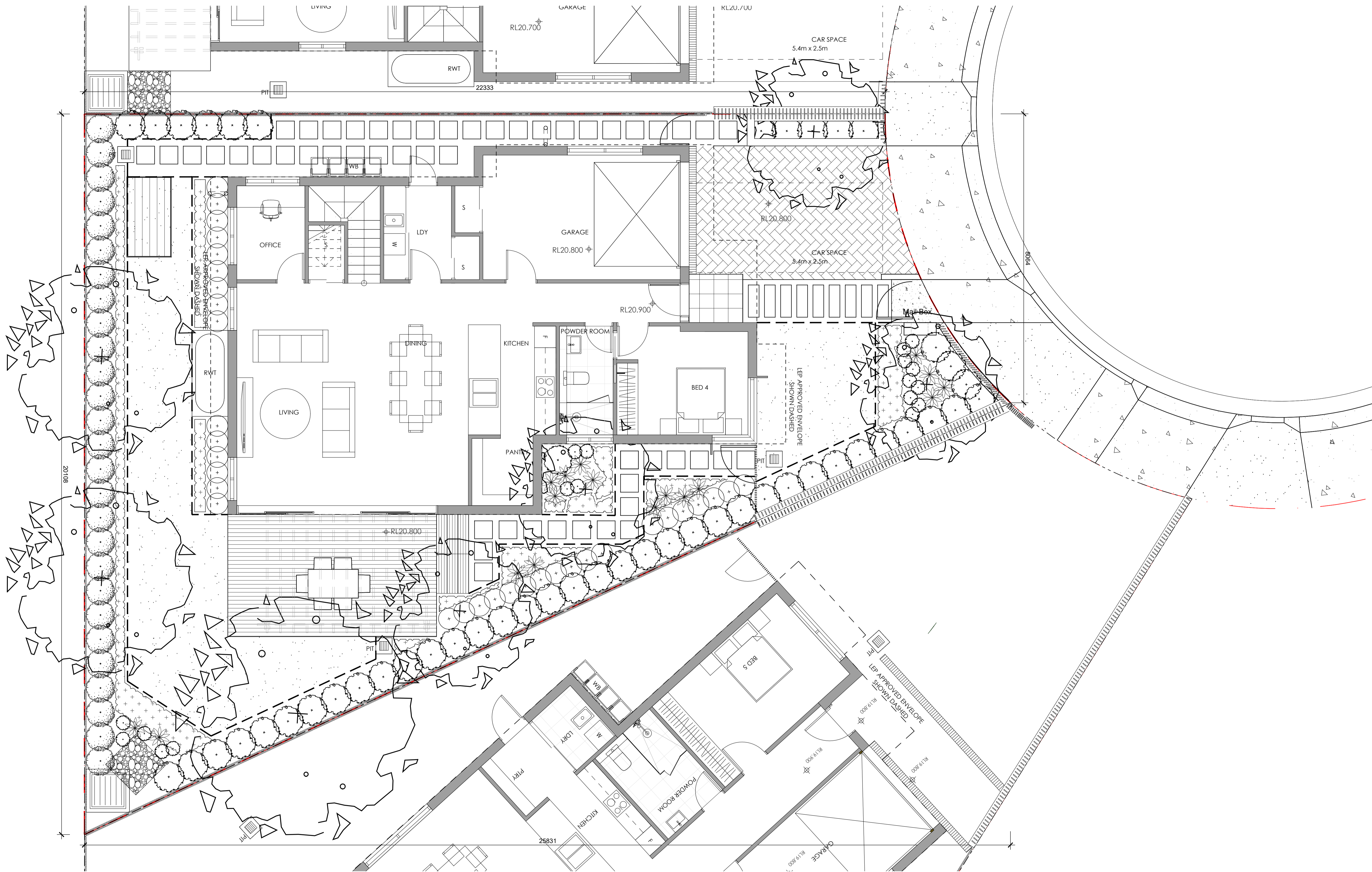

NOT FOR CONSTRUCTION

© 2021 Site Image (NSW) Pty Ltd. ABN 44 801 262 380 as agent for Site Image NSW Partnership. All rights reserved. This drawing is copyright and shall not be reproduced or copied in any form or by any means (graphic, electronic or mechanical including photocopy) without the written permission of Site Image (NSW) Pty Ltd. Any license, expressed or implied, to use this document for any purpose whatsoever is restricted to the terms of the written agreement between Site Image (NSW) Pty Ltd and the instructing party.

The contractor shall check and verify all work on site (including work by others) before commencing the landscape installation. Any discrepancies are to be reported to the Project Manager or Landscape Architect prior to commencing work. Do not scale this drawing. Any required dimensions not shown shall be referred to the Landscape Architect for confirmation.

Legend	
	Existing tree to be removed - Refer Arborist report
	Proposed street trees
	Proposed trees
	Shrub and accent planting
	Groundcovers
	Lawn
	Timber edge
	Exposed concrete
	Paved driveway
	Timber decking
	Stepping pavers in gravel - Type 1
	Stepping pavers in gravel - Type 2
	Mail box
	Clothing lines
	Property boundary

Key Plan

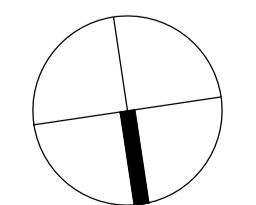

SITE IMAGE
 Landscape Architects
 Level 1, 3-5 Baptist Street
 Redfern NSW 2016
 Australia
 Tel: (61 2) 8332 5600
 Fax: (61 2) 9598 2877
 www.siteimage.com.au

Client
SKYCORP AUSTRALIA
 Project
Proposed Dwellings
 10 Fern Creek Road
 Warriewood

Drawing Name
Landscape Plan
 - Lot 7

DEVELOPMENT APPLICATION
 Scale 1:50 @ A1
 Job Number
SS21-4780
 Drawing Number
107
 Issue
A

A	For Approval	PH	RS	18.10.2021
Issue	Revision Description	Drawn	Check	Date

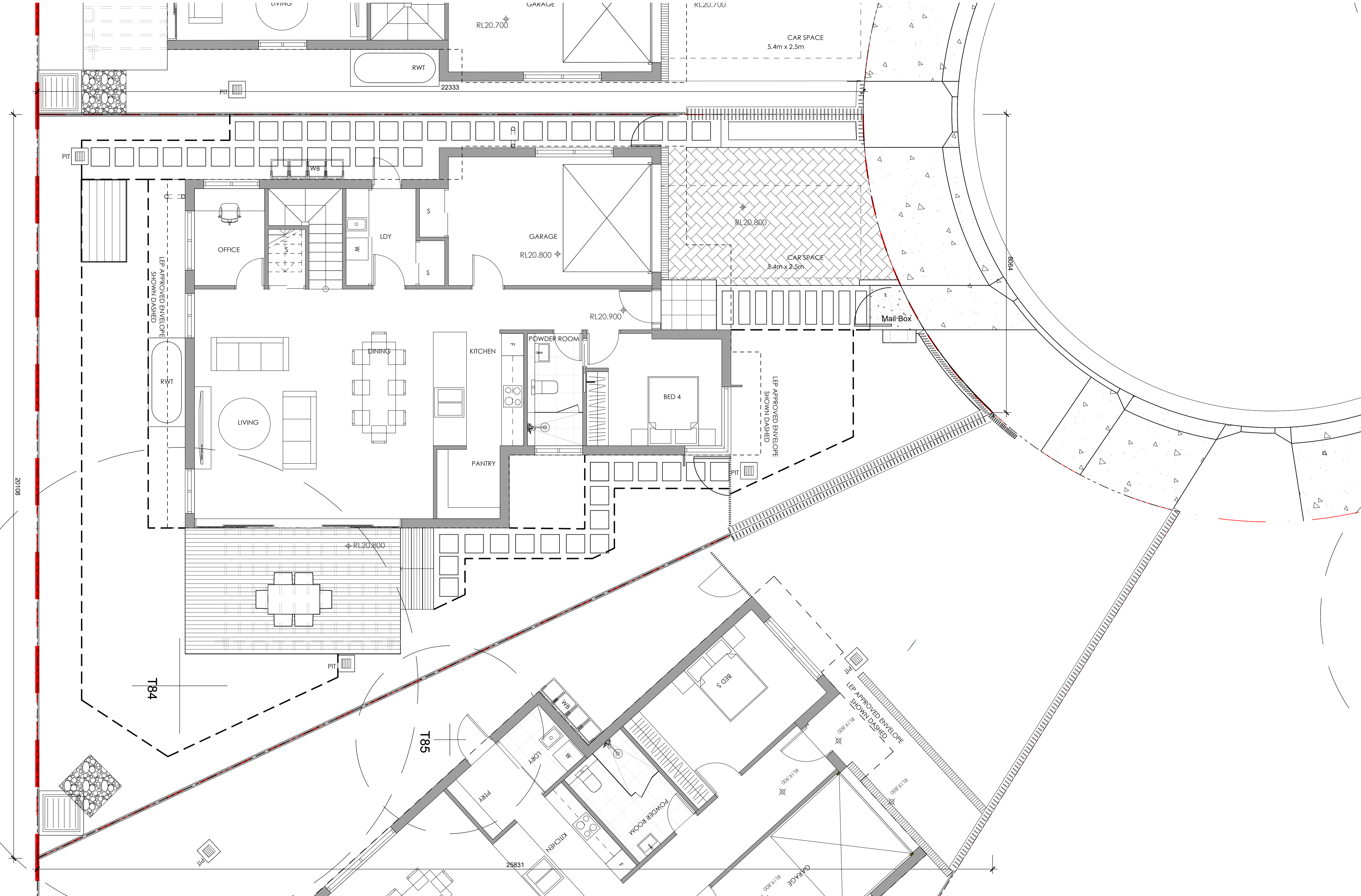

NOT FOR CONSTRUCTION

© 2021 Site Image (NSW) Pty Ltd. ABN 44 801 262 380 as agent for Site Image NSW Partnership. All rights reserved. This drawing is copyright and shall not be reproduced or copied in any form or by any means (graphic, electronic or mechanical including photocopy) without the written permission of Site Image (NSW) Pty Ltd. Any license, expressed or implied, to use this document for any purpose whatsoever is restricted to the terms of the written agreement between Site Image (NSW) Pty Ltd and the instructing party.

The contractor shall check and verify all work on site (including work by others) before commencing the landscape installation. Any discrepancies are to be reported to the Project Manager or Landscape Architect prior to commencing work. Do not scale this drawing. Any required dimensions not shown shall be referred to the Landscape Architect for confirmation.

- Legend**
- Timber edge
 - Exposed concrete
 - Paved driveway
 - Timber decking
 - Stepping pavers in gravel - Type 1
 - Stepping pavers in gravel - Type 2
 - Mail box
 - Clothing lines
 - Property boundary
 - Existing tree to be removed

Key Plan

SITE IMAGE
 Landscape Architects
 Level 1, 3-5 Baptist Street
 Redfern NSW 2016
 Australia
 Tel: (61 2) 8332 5600
 Fax: (61 2) 9698 2877
 www.siteimage.com.au

Client
SKYCORP AUSTRALIA
 Project
Proposed Dwellings
10 Fern Creek Road
Warriewood

Drawing Name
Landscape Hardscape Plan
- Lot 7

DEVELOPMENT APPLICATION
 Scale 1:50 @ A1
 Job Number
SS21-4780
 Drawing Number
307
 Issue
A

A For Approval
 PH RS 18.10.2021
 Drawn Check Date

Let me finish all sets first, then back to that. Thanks for your markup. I came very early this morning, should done that before lunch.

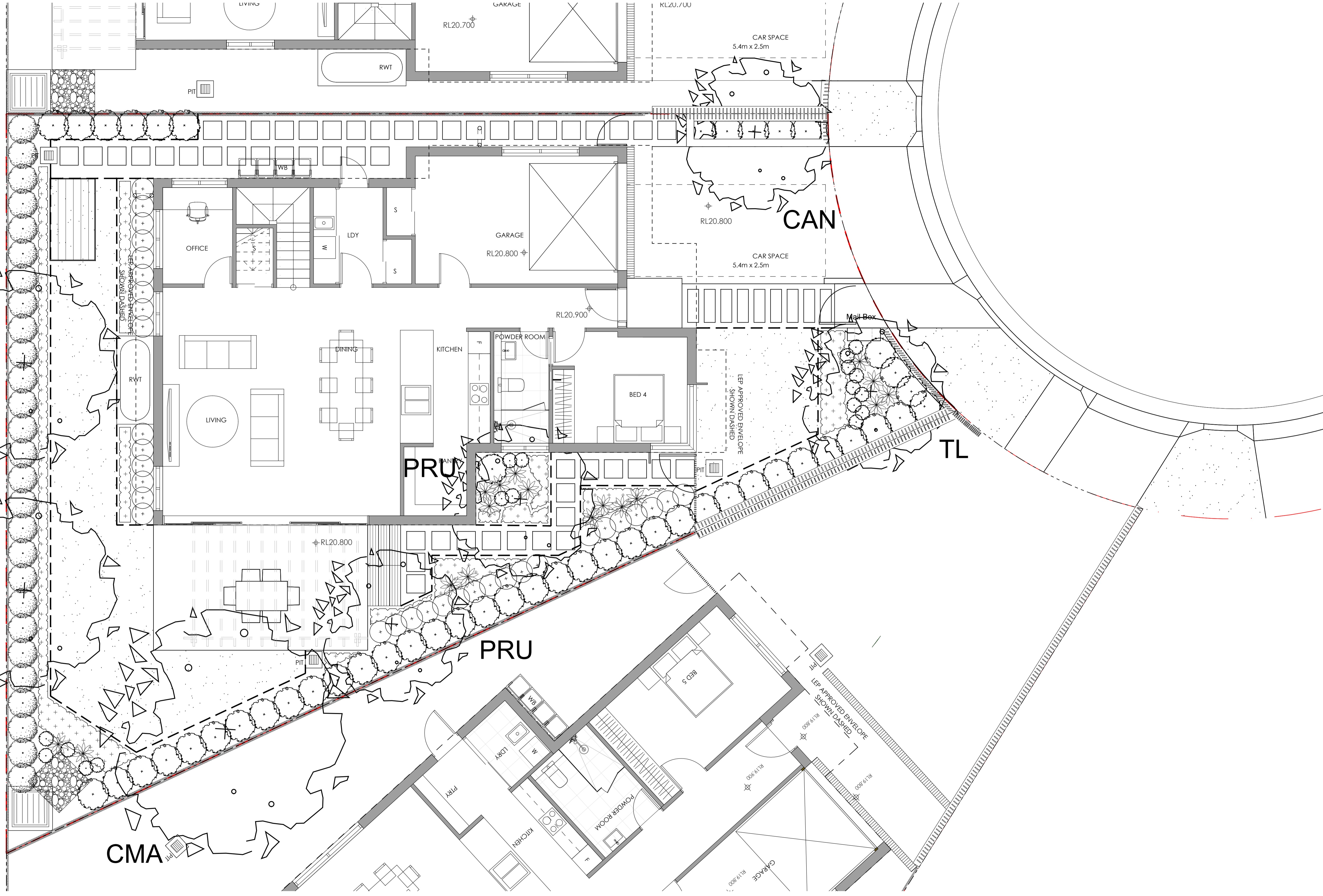

NOT FOR CONSTRUCTION

© 2021 Site Image (NSW) Pty Ltd. ABN 44 801 262 380 as agent for Site Image NSW Partnership. All rights reserved. This drawing is copyright and shall not be reproduced or copied in any form or by any means (graphic, electronic or mechanical including photocopy) without the written permission of Site Image (NSW) Pty Ltd. Any license, expressed or implied, to use this document for any purpose whatsoever is restricted to the terms of the written agreement between Site Image (NSW) Pty Ltd and the instructing party.

The contractor shall check and verify all work on site (including work by others) before commencing the landscape installation. Any discrepancies are to be reported to the Project Manager or Landscape Architect prior to commencing work. Do not scale this drawing. Any required dimensions not shown shall be referred to the Landscape Architect for confirmation.

- Legend**
- Existing tree to be removed
Refer Architect report
 - Proposed street trees
By others
 - Proposed trees
 - Shrub and accent planting
 - Groundcovers

Indicative plant schedule refer to drawing sheet 507

Key Plan

SITE IMAGE

 Landscape Architects
 Level 1, 3-5 Baptist Street
 Redfern NSW 2016
 Australia
 Tel: (61 2) 8332 5600
 Fax: (61 2) 9598 2877
 www.siteimage.com.au

Client
SKYCORP AUSTRALIA
 Project
Proposed Dwellings
 10 Fern Creek Road
 Warriewood

Drawing Name
Landscape Planting Plan
 - Lot 7

DEVELOPMENT APPLICATION
 Scale 1:50 @ A1
 Job Number
SS21-4780
 Drawing Number
407
 Issue
A

Issue	For Approval	Revision Description	Drawn	Check	Date
A	For Approval		PH	RS	18.10.2021

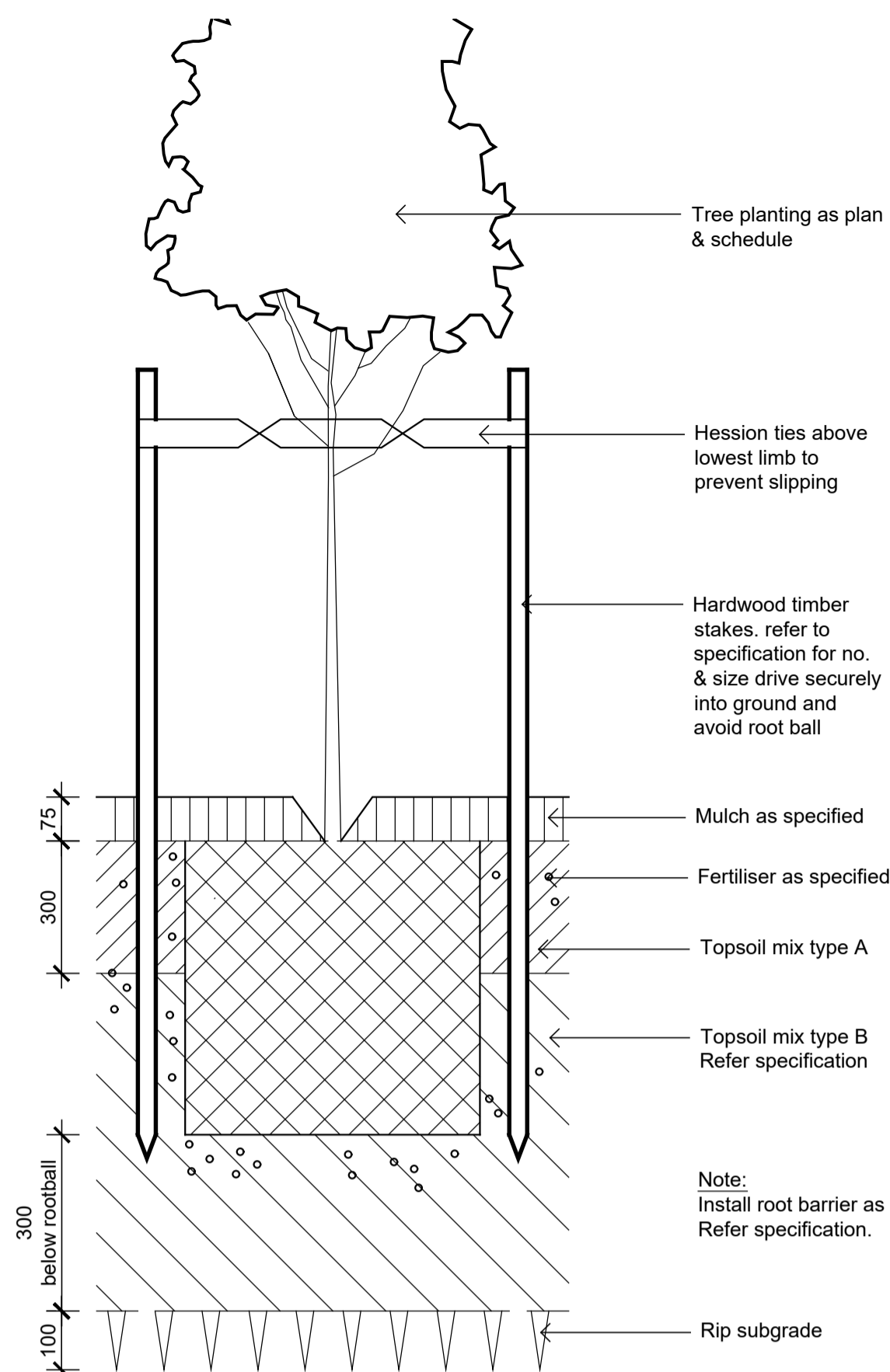

1 Detail 75-200L Tree Planting on Grade
1:10

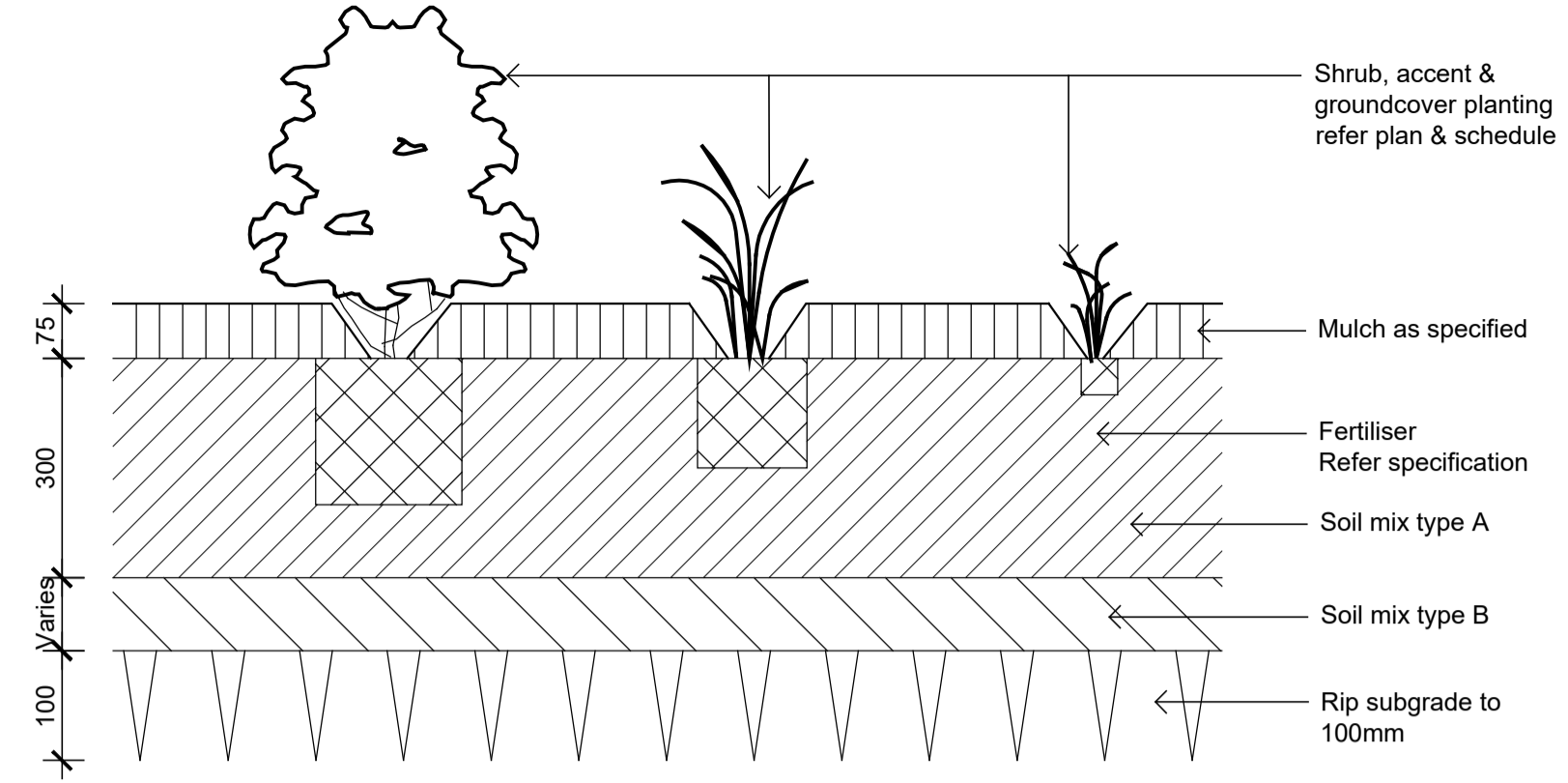

2 Detail Shrub Accent & Groundcover Planting on Grade
1:10

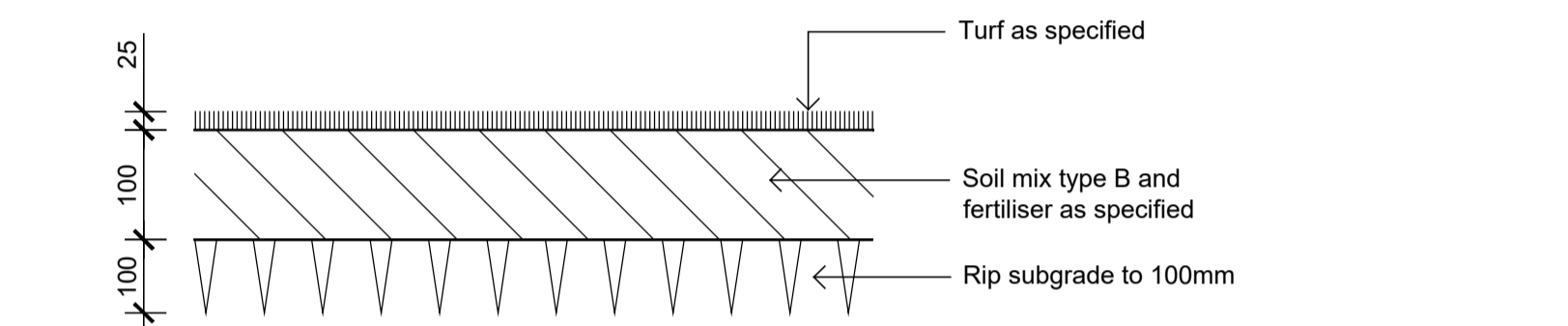

3 Detail Turf on Even Grade
1:10

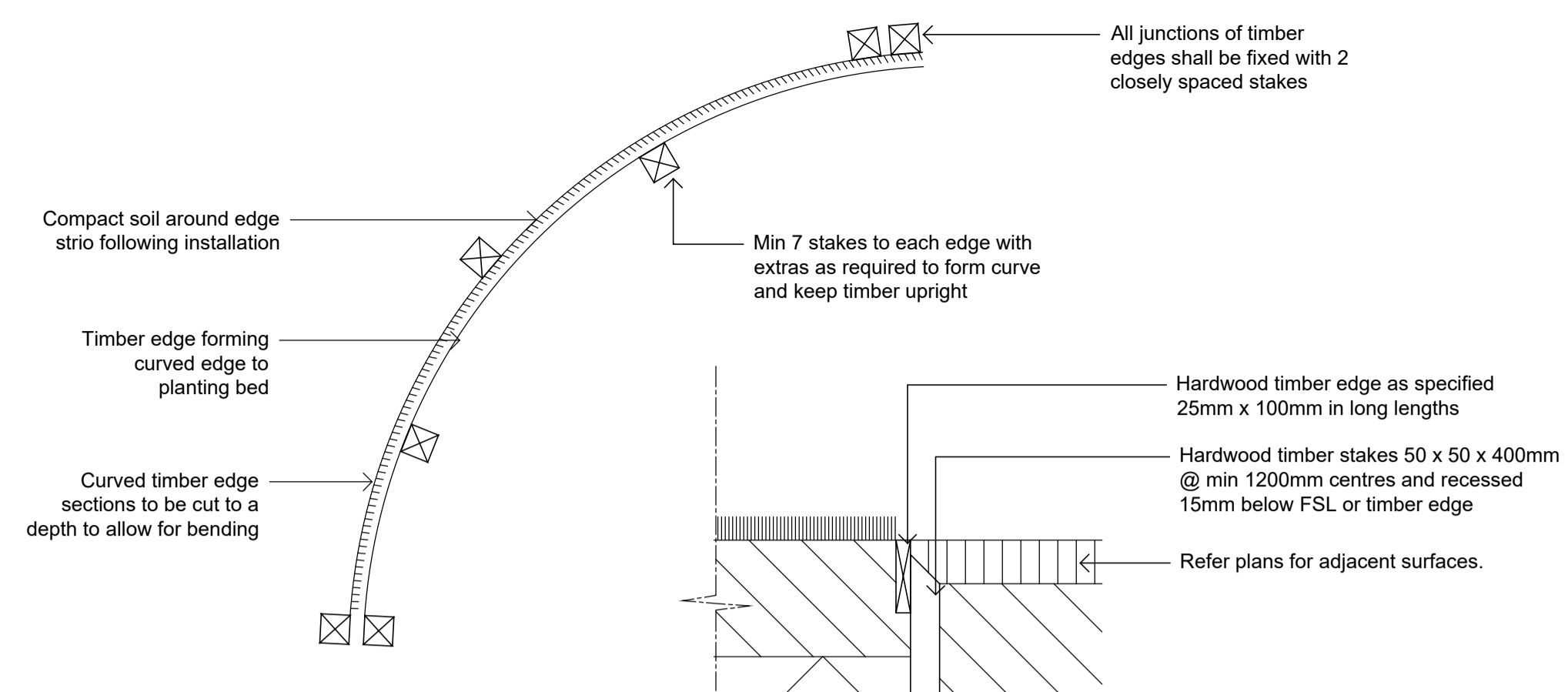

4 TIMBER EDGE - PLAN & SECTION
SCALE 1:10

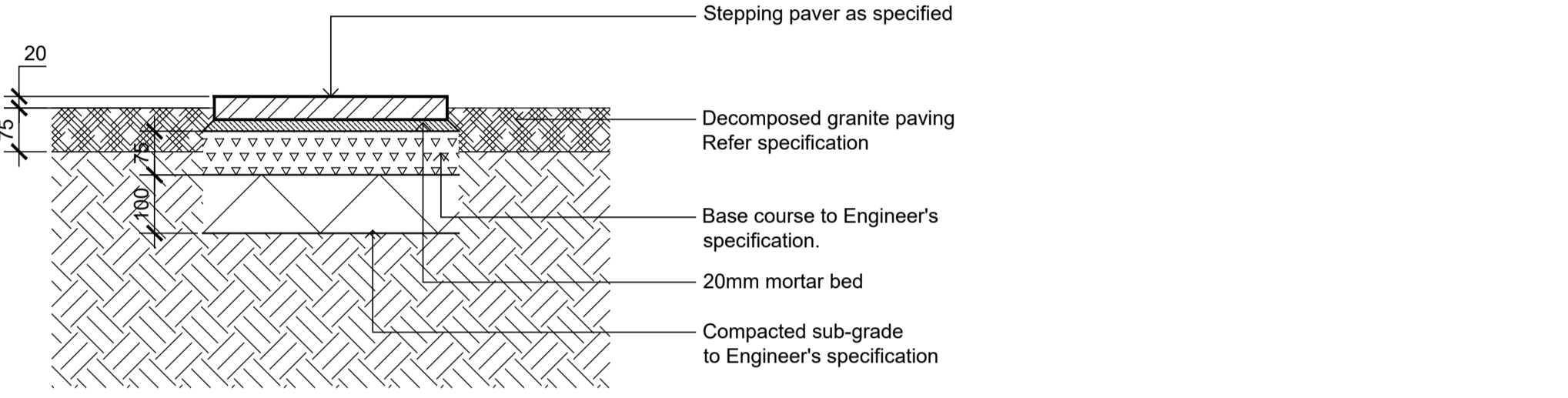

5 STEPPING PAVER IN DECOMPOSED GRANITE ON GRADE
SCALE 1:10

LANDSCAPE SPECIFICATION NOTES

GENERALLY
THE CONTRACTOR SHALL PLACE ORDERS FOR THE DELIVERY OF ALL MATERIALS, SUPPLIES, ETC., IMMEDIATELY AFTER SIGNING THE CONTRACT AND ENSURE THE SUPPLIERS GUARANTEE DELIVERY AT ALL TIMES TO ACCORD WITH THE CONSTRUCTION PROGRAM.

SITE PREPARATION
ENSURE ALL PROVISIONS FOR LANDSCAPE TO BE PROVIDED BY THE BUILDER ARE COMPLETE AND ALL CONTRACTORS RUBBISH AND DEBRIS IS REMOVED;

DRAINAGE CELL AND FILTER FABRIC
FOR ON-SLAB AREAS INSTALL AN APPROVED 'DRAINAGE CELL' PRODUCT TO COMPREHENSIVELY COVER THE BOTTOM OF ALL PLANTERS.

OVER DRAINAGE CELL TO ON-SLAB AREAS, A POLYFELT GEOTEXTILE LINING (AS SUPPLIED BY 'POLYFELT TS' OR APPROVED EQUIVALENT) IS TO BE INSTALLED TO COVER THE BOTTOM OF ALL PLANTERS, TURNED UP 300MM AND TAPED TO THE PLANTER SIDES TO ENSURE SOIL MIX DOES NOT ESCAPE INTO DRAINAGE OUTLETS/HOLES.

INSTALL MIN. 50MM COARSE RIVER SAND OVER ALL GEOTEXTILE LINING PRIOR TO INSTALLATION OF SOIL MIX.

ARBORIST MANAGEMENT OF TREE PROTECTION
A QUALIFIED AND APPROVED ARBORIST IS TO BE CONTRACTED TO UNDERTAKE OR MANAGE THE INSTALLATION OF PROTECTIVE FENCING, AND TO UNDERTAKE SUCH MEASURES AS HE DEEMS APPROPRIATE TO PRESERVE THE SUBJECT TREES TO BE RETAINED. THE ARBORIST IS TO BE RETAINED FOR THE ENTIRE CONTRACT PERIOD TO UNDERTAKE ONGOING MANAGEMENT AND REVIEW OF THE TREES.

IMPORTED SOIL MIX
IMPORTED LIGHTWEIGHT SOIL MIX FOR ON-SLAB AREAS AND POTS: LIGHTWEIGHT SOIL MIX SHALL BE COMPOSED OF THE FOLLOWING MATERIALS AND MIXED IN THE GIVEN PROPORTIONS TO PRODUCE A MATERIAL WITH A PH 6.0-6.5

SOIL MIX PER CUBIC METRE SHALL CONSIST OF:
- 30% KENTHURST BLACK LOAM
- 30% DOUBLE WASHED COARSE SAND
- 20% AUSTRALIAN PEAT
- 10% COMPOSTED BARK FINES
- 10% COMPOSTED HARDWOOD DUST

FERTILISER PER CUBIC METRE SHALL CONSIST OF
- 500GMS CALCIUM NITRATE
- 500GMS POTASSIUM SULPHATE
- 750GMS SUPERPHOSPHATE MICRO FINE
- 1 KG IBDU (NITROGEN SLOW RELEASE)
- 1 KG SLOW RELEASE NUTRICOTE

NOT FOR CONSTRUCTION

PLANT MATERIAL

ALL PLANTS SHALL BE WELL GROWN, DISEASE FREE NURSERY STOCK, AND TRUE TO SPECIES TYPE. NO SPECIES SHALL BE SUBSTITUTED WITHOUT THE APPROVAL OF THE SUPERINTENDENT. NO VARIEGATED STRAIN SHALL BE USED UNLESS NOMINATED.

ALL PLANTS SHALL BE OF THE SIZE AND QUALITY CONSISTENT WITH THE NORMAL INDUSTRY EXPECTATION FOR THE NOMINATED CONTAINER SIZE. PLANTS NOT CONSISTENT WITH THE ABOVE MAY BE REJECTED WITH REPLACEMENT STOCK SUBJECT TO THE APPROVAL OF THE SUPERINTENDENT.

ALLOW TWO AGRIFORM SLOW RELEASE PELLETS PER 5-25 LITRE PLANT AND ONE PER 150MM PLANT. ALL FERTILISER IS TO BE APPLIED IN ACCORDANCE WITH THE MANUFACTURERS INSTRUCTIONS.

MULCH
TO MASS PLANTING AREAS AND STREET TREES INSTALL 75MM THICKNESS OF GRADED PINE BARK AS SUPPLIED BY AUSTRALIAN NATIVE LANDSCAPES P/L OR APPROVED EQUIVALENT. ALL MULCH SHALL BE FREE OF VEGETATIVE REPRODUCTIVE PARTS OF WEEDS

IRRIGATION SYSTEM
SUPPLY AN AUTOMATIC WATERING SYSTEM USING 'TORO IRRIGATION SYSTEM' OR SIMILAR APPROVED, WITH MICRO-JET SPRINKLER HEADS AND LOW DENSITY, RUBBER MODIFIED POLYPROPYLENE RETICULATION, TO INCLUDE FILTERS, BENDS, JUNCTIONS, ENDS AND OTHER ANCILLARY EQUIPMENT. THE LANDSCAPER SHALL NOMINATE HIS SOURCE OF SUPPLY FOR THE WATERING SYSTEM AND OBTAIN APPROVAL FROM THE SUPERINTENDENT BEFORE PLACING ORDERS FOR EQUIPMENT OR SUPPLY.

A SCHEMATIC PLAN OF THE PROPOSED IRRIGATION SYSTEM IS TO BE PREPARED BY THE CONTRACTOR, SHOWING SOLENOIDS, PIPE DIAMETERS, AND ALL NOZZLE AND TRICKLE ATTACHMENT TYPES (INCLUDING SPRAY/HEAD ANGLE), FOR REVIEW BY THE SUPERINTENDENT PRIOR TO INSTALLATION

THE CONTRACTOR IS TO LIASE WITH THE HYDRAULIC ENGINEER AND COUNCIL AS NECESSARY, TO ENSURE THE THE IRRIGATION SYSTEM CONFORMS WITH ALL THE COUNCIL AND WATER BOARD CODES AND REQUIREMENTS.

PROVIDE AN AUTOMATIC CONTROLLER THAT PROVIDES FOR TWO WEEK SCHEDULING AND HOURLY MULTI-CYCLE OPERATION. THE CONTROLLER SHALL MANUAL OVERRIDE. PROGRAMMING SHALL BE UNDERTAKEN BY THE CONTRACTOR WHO SHALL ADVISE ON THE OPERATION OF THE SYSTEM.

PROVISION OF SECURE HOUSING FOR THE AUTOMATIC IRRIGATION CONTROLLER TO BE LOCATED IN ASSOCIATION WITH THE LANDSCAPE CONTRACTOR AND LOCATION CONFIRMED BY THE SUPERINTENDENT. WIRING TO CONNECT REMOTE SOLENOID LOCATIONS IS TO BE PROVIDED. THE CONTROLLER SHALL BE LOCATED IN A DRY PLACE, PROTECTED FROM THE WEATHER, AND ALL CABLE CONNECTIONS SHALL BE MADE WITH WATERPROOF CONNECTORS.

WATER SUPPLY POINTS TO BE SUPPLIED BY BUILDER.

IT SHALL BE THE CONTRACTOR'S RESPONSIBILITY TO ENSURE AND GUARANTEE SATISFACTORY OPERATION OF THE IRRIGATION SYSTEM.

AFTER THE SYSTEM HAS BEEN INSTALLED TO THE SATISFACTION OF THE SUPERINTENDENT, THE INSTALLATION SHALL BE TESTED UNDER KNOWN WORKING CONDITIONS. ACCEPTANCE OF THE INSTALLED PLANT AND EQUIPMENT SHALL BE SUBJECT TO THESE BEING SATISFACTORY.

STEPPING STONES
PRE CAST CONCRETE STEPPING STONES SHALL BE INSTALLED ON CONSOLIDATED BLUE METAL SUB-BASE.

TREATED PINE TIMBER EDGING
TIMBER EDGE: 100 X 25mm CCA TREATED RADIATA PINE
TIMBER STAKES: 50 X 50 X 500mm CCA TREATED RADIATA PINE-SHARPENED AT ONE END.
INSTALL IN LOCATIONS SHOWN ON THE DRAWINGS FLUSH TO FINISHED SURFACE LEVELS.

TURF
TURF ALL LANDSCAPE AREAS AS SHOWN ON THE LANDSCAPE DRAWINGS. TURF IS TO HAVE AN EVEN THICKNESS OF NOT LESS THAN 25mm. OBTAIN TURF FROM AN APPROVED GROWER. FURNISH A WARRANTY FROM THE GROWER THAT THE TURF IS FREE FROM WEEDS AND OTHER FOREIGN MATTER. DELIVER TURF TO THE SITE WITHIN 24 HOURS OF BEING CUT, AND LAY IT WITHIN 24 HOURS OF BEING DELIVERED.

TO PREPARE GRADED AREAS TO RECEIVE TURF, EXCAVATE THE AREA AND CULTIVATE SO AS TO ALLOW FOR IMPORTING OF 100mm OF TURF UNDERLAY SOIL. REMOVE ALL STONES OVER 50mm Ø AND REMOVE ALL WEEDS AND FOREIGN MATTER. SPREAD SOIL MIX A,B,S TO A DEPTH OF 100mm AND GRADE TO APPROPRIATE LEVELS TO ACHIEVE GENERAL EVEN GRADES TO DRAINAGE OUTLETS INSTALLED BY OTHERS.

LAY THE TURF ALONG THE LAND CONTOURS WITH STAGGERED, CLOSE BUTTED JOINTS, SO THAT THE FINISHED TURF SURFACE IS FLUSH WITH ADJACENT FINISHED SURFACES OF PAVING AND THE LIKE. AS SOON AS PRACTICABLE AFTER LAYING, ROLL THE TURF WITH A ROLLER WEIGHING NOT MORE THAN 90kg PER METRE OF WIDTH FOR SANDY OR LIGHT SOILS.

WATER AS NECESSARY TO KEEP THE SOIL MOIST TO A DEPTH OF 100MM. PROTECT NEWLY TURFED AREAS AGAINST TRAFFIC UNTIL GRASS IS ESTABLISHED. FERTILISE TWO WEEKS AFTER LAYING FERTILISE A,B,S

'TOP DRESS' THE TURF WHEN IT IS ESTABLISHED TO A DEPTH OF 10MM WITH COARSE WASHED RIVER SAND. RUB THE DRESSING WELL INTO THE JOINTS AND CORRECT ANY UNEVENNESS IN THE TURF SURFACES.

MAINTENANCE
THE CONTRACTOR SHALL MAINTAIN THE CONTRACT AREAS BY THE IMPLEMENTATION OF INDUSTRY ACCEPTED HORTICULTURAL PRACTICES, AS WELL AS RECTIFYING ANY DEFECTS THAT BECOME APPARENT IN THE WORKS UNDER NORMAL USE.

THE CONTRACTOR SHALL MAINTAIN THE WORKS AND MAKE GOOD ALL THE DEFECTS.

LANDSCAPE MAINTENANCE SHALL INCLUDE BUT NOT BE LIMITED TO THE FOLLOWING: WATERING, ADJUSTMENT OF THE IRRIGATION SYSTEM, RUBBISH REMOVAL, REPLACING FAILED PLANTS, MAINTAINING MULCH, PRUNING, INSECT AND DISEASE CONTROL, AND CLEANING OF THE SURROUNDING AREA.

INDICATIVE PLANT SCHEDULE - Lot 7

FERN CREEK ROAD WARRIEWOOD INDICATIVE PLANT LIST - PLANTS TO BE LABELLED FOR CC STAGE

CODE	BOTANIC NAME	COMMON NAME	MATURE SIZE (H x W) (m)	PROPOSED POT SIZE
Trees and Palms				
Apa	Acer palmatum	Japanese Maple	4 x 4	45L
Aco	Angophora costata	Smooth Barked Apple	25 x 8	75L
Afl	Angophora floribunda	Rough Barked Apple	25 x 8	75L
Bcl	Banksia integrifolia	Lemon scented Myrtle	9 x 5	45L
BeB	Banksia ericifolia 'Burgundy'	Heath Banksia	5m	4m
CoA	Carica chinensis 'Xavondae'	Chinese Red Bud	5 x 4	100L
Cma	Corymbia citriodora	Lemon Scented Gum	20 x 8	75L
Can	Cupaniopsis anacardioides	Tuckeroo	7 x 5	100L
Eer	Eucalyptus robusta	Swamp Mahogany	25 x 8	75L
Epu	Eucalyptus punctata	Grey Gum	15 x 8	75L
Epu	Eucalyptus tereticornis	Forest Red Gum	15 x 8	75L
Fgr	Fraxinus griffithii	Evergreen Ash	7 x 4	75L
FR	Fraxinus 'Raynoco'	Claret Ash	15 x 5	75L
HCR	Hibiscus tiliaceus 'Rubra'	Cotton Tree	7 x 5	75L
Hll	Howea forsteriana	Kentia Palm	7 x 4	75L
Hll	Hymenosporum flavum	Native Frangipani	6 x 5	75L
Lin	Lagerstroemia indica	Creepe Myrtle	6 x 3	75L
LS	Lagerstroemia 'Sioux'	Sioux Creepe Myrtle	4 x 3	75L
ML	Magnolia grandiflora 'Little Gem'	Dwarf Magnolia	5	75L
MLG	Magnolia Little Gem	Magnolia Little Gem	5 x 3	75L
Prv	Plumeria rubra	Red Frangipani	6	75L
Pro	Plumeria obtusa	White Frangipani	6	75L
Pe	Prunus elvins	Purple Plum	3 x 3	75L
PC	Pyrus 'Capita'	Capital Pyrus	10 x 3	75L
Sg	Syncarpia glomulifera	Turpentine	to 50m	75L
Sl	Syzygium luehmannii	Small-leaved Lillypilly	4 - 8 x 2 - 4	75L
Sa	Syzygium australe 'Pinnacle'	Brush Cherry	8 x 4	75L
Ss	Syzygium smithii	Lilly Pilly	8 x 4	75L
Ti	Tristania laurina	Water Gum	10	75L
TL	Tristania lusciosa	Water Gum	9 x 7	75L
Wf	Waterhousea floribunda	Weeping Lilly Pilly	15	75L
SHRUBS				
Asm	Acmena smithii 'Minor'	Lilly Pilly	3 x 2	300mm
As	Acmena smithii var. minor	Dwarf Lilly Pilly	3 x 2	300mm
Bs	Banksia spinosa	Hairpin Banksia	1.5 x 1.0	300mm
Bmj	Buxus microphylla japonica	Japanese box hedge	2.5 x 2	300mm
Cv	Callistemon citrinus 'White Anzac'	Lemon Scented Bottlebrush	3 x 2	300mm
Cgu	Caralopetalum guimifera	NSW Christmas Bush	5 x 2	300mm
Co	Chrysia tenata	Mexican Orange	2 x 2	300mm
Cpu	Coleonema pulchrum	Pink Dosma	1.5 x 1.5	300mm
Cre	Coprosma repens	Mirror Bush	3 x 2	300mm
Cr	Cycas revoluta	Sago Palm	1 x 2	300mm
Ga	Gardenia augusta 'Florida'	Gardenia	1 X 1	300mm
GRG	Grevillea 'Robin Gordon'	Grevillea	2 x 1.5	300mm
La	Lavandula	Lavender	1 x 1	300mm
LC	Loropetalum 'China Pink'	China Pink	1 x 1.5	300mm
Mn	Melaleuca nesophylla	Showy Honey Myrtle	3 x 2	300mm
MT	Metrosideros 'Tahti'	NZ Xmas Bush	1 x 1	300mm
Mp	Muraya paniculata	Orange Jessamine	3 x 2	300mm

CODE	BOTANIC NAME	COMMON NAME	MATURE SIZE (H x W)	PROPOSED POT SIZE
NGS	Nandina 'Gulf Stream'	Nandina	0.7	300mm
PX	Philodendron 'Xanadu'	Xanadu	1 x 1	300mm
PRR	Photinia x fraseri 'Red Robin'	Photinia Red Robin	3 x 2	300mm
PGP	Pittosporum 'Green Pillar'	Green Pillar	3 x 3	300mm
PMI	Pittosporum tobira 'Miss Muffet'	Dwarf Pittosporum	1 x 1	300mm
RCP	Rhaphiophyes 'Oriental Pearl'	Oriental Pearl	1 x 1	300mm
SaS	Syzygium australe 'Select'	Lilly Pilly	3 x 2	300mm
SaTT	Syzygium australe 'Tiny Trev'	Dwarf Lilly Pilly	0.7	300mm
SC	Syzygium 'Cascade'	Weeping 'Cascade' Lilly Pilly	0.7	300mm
TJ	Tibouchina 'Jules'	Glory Bush	1m	300mm
VE	Viburnum 'Emerald Lustre'	Emerald Lustre	4 x 4	300mm
WWG	Westringia 'Wynyabbie Gem'	Wynyabbie Rosemary	1	300mm
ACCENT PLANTS				
Aim	Alcantarea imperialis		1.5 x 1.5	300mm
Alc	Alpinia caerulea	Native Ginger	2	300mm
Ael	Aspidistra elatior	Cast Iron Plant	1	300mm
CBS	Cordyline 'Burgundy Spire'		1 x 1	300mm
Cs	Cordyline stricta	Cordyline	3	300mm
Cp	Crinum pendunculatum	Swamp Lily	600mm	300mm
De	Doryanthes excelsa	Gynera Lily	3	300mm
Px	Philodendron 'Xanadu'		1 x 0.8	300mm
PBB	Phormium 'Bronze Baby'	Bronze NZ Flax	1	300mm
PYW	Phormium 'Yellow Wave'	Yellow Wave NZ Flax	1	300mm
Rhu	Raphis humilis		0.3	300mm
Re	Rhipis excelsa		1.5 x 1	300mm
Sre	Streitizia reginae	Bird Of Paradise	1.2	300mm
Sjr	Streitizia juncea	Narrow Leaved Bird Of Para	1.2	300mm

GRASSES / GROUNDCOVERS / CLIMBERS		
AO	Agapanthus orientalis	Agapanthus
Anu	Asplenium australasicum	Bird's Nest Fern
Cg	Carpobrotus glaucascens	Pig Face
Cm	Clivia miniata	Kaffir Lily
DB	Dianella 'Breeze'	Breeze Flax Lily
Dg	Dietes grandiflora	Wild Iris
Gs	Gazania sp.	Gazania
GH	Gazania x hybrida	Gazania
GpM	Grevillea pookiana 'Royal Mantle'	Prostrate Grevillea
Hs	Hardenbergia 'Meema'	Golden Guinea Vine
Hsc	Hibbertia scandens	Knobby Club Rush
Jpo	Jasminum polyanthum	Pink Jasmine
LJR	Liriope muscari 'Just Right'	Turf Lily
U	Lomandra longifolia	Mat Rush
LT	Lomandra longifolia 'Tanika'	Tanika Mat Rush
MY	Myoporum 'Arens'	Native Violet
Ppa	Pandorea pandorana	Wonga Wonga Vine
PaPL	Pennisetum alpecuroides 'Purple Lea'	Purple Lea Swamp Foxtail
PI	Poa labillardieri	Tussock Grass
Sam	Scaevola aemula 'Mauve Clusters'	Purple Fan Flower
Tau	Themeda australis	Kangaroo Grass
Tja	Trachelospermum jasminoides	Star Jasmine
Vhe	Viola hederacea	Native Violet

© 2021 Site Image (NSW) Pty Ltd. ABN 44 801 262 380 as agent for Site Image NSW Partnership. All rights reserved. This drawing is copyright and shall not be reproduced or copied in any form or by any means (graphic, electronic or mechanical including photography) without the written permission of Site Image (NSW) Pty Ltd. Any license, expressed or implied, to use this document for any purpose what so ever is restricted to the terms of the written agreement between Site Image (NSW) Pty Ltd and the instructing party.

The contractor shall check and verify all work on site (including work by others) before commencing the landscape installation. Any discrepancies are to be reported to the Project Manager or Landscape Architect prior to commencing work. Do not scale this drawing. Any required dimensions not shown shall be referred to the Landscape Architect for confirmation.

A	For Approval	PH	RS	18.10.2021
Issue	Revision Description	Drawn	Check	Date

Legend

Key Plan



Client
SKYCORP AUSTRALIA
Project
Proposed Dwellings
10 Fern Creek Road
Warriewood

Drawing Name
Landscape Specification / Details
- Lot 7

Scale As Shown
Job Number
SS21-4780
Drawing Number
507 A
Issue