

LANDSCAPE SPECIFICATION

SITE ESTABLISHMENT

ALL RUBBISH, DEBRIS, FALLEN BRANCHES SHALL BE CLEARED FROM LANDSCAPED AREAS AND DISPOSED OF USING SKIP BINS ONSITE OR BY TRANSPORTING TO THE LOCAL WASTE MANANAGEMENT FACILITY. ANY UNUSED BRICKS, CONCRETE BLOCKS OR TIMBER SHOULD BE EITHER RE-USED ONSITE WHERE POSSIBLE OR RECYCLED AT THE LOCAL WASTE MANANAGEMENT FACILITY.

TREE PROTECTION

TREES TO BE RETAINED SHALL BE PROTECTED DURING SITE WORKS AND TREE PROTECTION BARRIERS INSTALLED ACCORDING TO TREE PROTECTION DETAILS. NO EXCAVATION OR CHANGE IN SOIL LEVEL SHOULD TAKE PLACE AROUND THE BASE OF SUCH TREES. ANY ARBORIST REPORT MUST BE ADHERED TO AND TREE PROTECTION ZONES MAINTAINED WHERE APPLICABLE.

WEED ERADICATION

AREAS TO BE LANDSCAPED ARE TO BE SPRAYED WITH GLYPHOSATE AT THE RECOMMENDED RATE AT LEAST 1 WEEK PRIOR TO ANY LANDSCAPE WORKS TAKING PLACE IN ORDER TO ALLOW WEEDS TO DIE OFF. CARE IS TO BE TAKEN TO PROTECT REMAINING VEGETATION FROM THE HERBICIDE APPLICATION AND SHOULD ONLY BE UNDERTAKEN IN STILL WEATHER. ALL WEEDS ARE THEN TO BE DISPOSED OF APPROPRIATELY AT THE LOCAL WASTE MANANAGEMENT FACILITY.

GARDEN BED PREPERATION

ENSURE ALL GARDEN BEDS HAVE BEEN EXCAVATED TO 250MM BELOW FINISHED LEVELS. RIP THE SUBGRADE A FURTHER 100MM IN DEPTH. INSTALL PREMIUM GARDEN SOIL OR MIX NATURAL TOP SOIL WITH IMPORTED SOIL TO A DEPTH OF 250MM. INSTALL 75MM DEPTH OF LEAF LITTER MULCH FROM ANL LANDSCAPE SUPPLIES OR EQUIVALENT.

LAWN AREA PREPERATION

EXCAVATE LAWN AREAS TO A DEPTH OF 100MM BELOW REQUIRED FINISHED LEVELS. DO NOT EXCAVATE WITHIN WITHIN TREE PROTECTION ZONES WHERE APPLICABLE OR WITHIN 1500MM OF THE TRUNK OF ANY EXISTING TREES TO BE RETAINED. ENSURE THAT ALL SURFACE WATER IS DIRECTED TOWARD ANY DRAINAGE PITS, KERBS AND AWAY FROM ANY BUILDINGS. SUBGRADE IS TO BE RIPPED TO A DEPTH OF 150MM AND A 50MM DEEP LAYER OF TURF UNDERLAY INSTALLED ON TOP. LAWNS SHOULD HAVE AN EVEN GRADE SO THAT NO PONDING OR POOLING OCCURS. 'SIR LAUNCHER' FERTILISER OR EQUIVELANT SHOULD BE SPREAD OVER LAWN AREAS PRIOR TO LAYING TURF. LAY 'SIR WALTER BUFFALO' TURF ROLLS CLOSELY BUTTED ENSURING NO GAPS BETWEEN ARE PRESENT. ROLL AND WATER THOROUGHLY AFTER LAYING.

PLANTING

PLANTS ARE TO BE HEALTHY, FREE OF PEST/DISEASES AND TRUE TO TYPE & SPECIES. REFER TO LANDSCAPE PLAN FOR LOCATION AND SPACING. ALL PLANTS SHOULD BE PLACED IN A HOLE DUG TWICE THE SIZE OF THE POT. GENTLY TEESE THE ROOTS OF ANY POT BOUND PLANTS. THE BASE OF THE TRUNK SHOULD BE INSTALLED LEVEL WITH THE SURFACE OF THE GROUND AND DISH CREATED AROUND THE BASE OF EACH PLANT TO AID WITH WATER RETENTION. WATER THOROUGHLY AFTER PLANTING.

PLANT LIST

| TYPE | SYMBOL | BOTANIC NAME | COMMON NAME | MATURE HEIGHT X WIDTH | NATIVE? | QTY | POT SIZE |
|--|--------|----------------------------------|----------------------------|-----------------------|---------|-----|----------|
| TREES | | | | | | | |
| | CA | CUPANIOPSIS ANACARDIODES | TUCKEROO | 8M X 4M | YES | 3 | 45LTR |
| SHRUBS | | | | | | | |
| | Acl | ACACIA 'LIMELIGHT' | LIMELIGHT | 1M X 1M | YES | 4 | 200MM |
| GRASSES & STRAP LEAF PLANTS | | | | | | | |
| | Dtr | DIANELLA TASMANICA 'TAS RED' | TAS RED DIANELLA | 0.45M X 0.45M | YES | 5 | 140MM |
| HEDGES | | | | | | | |
| | Ascs | ACMENA SMITHII 'CHERRY SURPRISE' | CHERRY SURPRISE LILY PILLY | TRIMMED UP TO 1M | YES | 25 | 200MM |

STAKING

ALL TREES AND TOP HEAVY SCREENING SHRUBS SHOULD BE STAKED WITH 2 X 25MM X 25MM LONG TIMBER STAKES PER PLANT. LENGTH OF STAKES IS DEPENDENT ON THE HEIGHT AND STABILITY OF THE TREE/SHRUB. STAKES SHOULD BE FIRMLY POSITIONED. HESSIAN TAPE IS TO BE PLACED AROUND THE TREE AND STAKES ALLOWING SOME MOVEMENT IN ORDER TO ALLOW THE TRUNK TO DEVELOP STRENGTH OVERTIME.

GARDEN EDGING

USE EITHER '**HAVEN' BRICK EDGING** OR SIMILAR LAID ON A 50MM THICK BED OF MORTAR, OR '**TREATED TIMBER EDGING** SECURED WITH INGROUND TIMBER STAKES. ALL GARDENS ARE TO HAVE EDGING INSTALLED AND BE INSTALLED AS PER PLAN.

RETAINING WALLS

REFER TO MANUFACTURERS INSTRUCTIONS FOR CONSTRUCTION OF RETAINING WALLS. DETAILS ON THIS PLAN ARE A GUIDE ONLY.

COMPLETION

SITE IS TO BE CLEARED OF ANY SURPLUS MATERIALS AND DEBRIS PRIOR TO PRACTICAL COMPLETION. WORK IS TO BE COMPLETED TO THE SATISFACTION OF COUNCILS GUIDELINES AND ANY DA CONDITIONS

MAINTENANCE PERIOD

A 12 MONTH MAINTENANCE PERIOD FROM THE DATE OF PRACTICAL COMPLETION WILL APPLY. DURING THIS TIME THE OWNER IS RESPONSIBLE FOR RECTIFYING ANY DEFECTIVE WORK. DURING THE MAINTENACE PERIOD THE FOLLOWING ACTIVITIES ARE TO BE UNDERTAKEN.

a) REPLACEMENTS: ANY PLANTS/TREES THAT HAVE DIED SHALL BE REPLACED WITH THE SAME SPECIES AND SIZE AS INDICATED ON THIS PLAN. THE SPECIMENS MUST BE IN GOOD HEALTH AND FREE FROM PESTS AND DISEASES.

b) WATERING: REGULAR WATERING OF PLANTS IS REQUIRED. PLANTS SHOULD BE WATERED TWICE A WEEK WITHIN THE FIRST

2 MONTHS OF PLANTING AND AND DURING DRY PERIODS. LESS FREQUENT WATERING IS REQUIRED ONCE PLANTS ARE ESTABLISHED AND DURING PERIODS OF RAIN. THE CONTRACTOR/OWNER SHOULD USE THEIR DISCRETION.

c) GARDEN BEDS: GARDEN AREAS SHOULD BE REGULARLY WEEDED AND MULCH TOPPED UP IF REQUIRED. NO BARE SOIL IS TO BE PRESENT AND SPECIFIED DEPTHS MAINTAINED.

d) LAWN AREAS: LAWN AREAS SHALL BE MOWN REGULARLY (AT LEAST ONCE A WEEK IN GROWING SEASON) IN ORDER TO PROMOTE A THICK LAWN THAT OUTCOMPETES ANY WEEDS. LAWN CLIPPINGS ARE NOT TO BE SPREAD OVER GARDEN AREAS. ANY DEAD AREAS OF LAWN OCCURING THE MAINTENANCE PERIOD, ARE TO BE REPLACE WITH THE TURF VARIETY SPECIFED IN THE PLAN.

e) PRUNING: ADEQUATE HORTICULTURAL PRUNING METHODS SHOULD BE USED ON PLANTS AS BECOMES NECESSARY. ANY HEDGES ARE TO BE TRIMMED REGULARLY, DEAD AND DANGEROUS TREE BRANCHES PRUNED AND LIGHT PRUNING OF SHRUBS TO PROMOTE THICK FOLIAGE COVER.

f) FERTILISING: 'ORGANIC LIFE' FERTILISER OR EQUIVELANT SHALL BE APPLIED AS PER MANUFACTURERS INSTRUCTIONS TO ALL GARDEN BEDS ONCE PER MONTH. DYNAMIC LIFTER OR SIMILAR SHOULD BE APPLIED TO ALL LAWN AREAS TWICE A YEAR, ONCE IN MID SPRING AND ONCE IN EARLY SUMMER. WATER THOROUGHLY AFTER EACH APPLICATION OF FERTILISER.

Revision Schedule

| Issue: | Description: | By: | Date: |
|--------|-----------------|-----|----------|
| A | Submission Plan | OS | 20/04/21 |
| A | Submission Plan | OS | 20/04/21 |
| | | | |
| | | | |

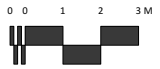
| | |
|------------------|---|
| Drafted: JS | Scale: 1:200  |
| Sheet: 2 of 4 | Reference: LP 01 |

Designed by:

Julian Saw
Diploma of Horticulture
(Landscape Design)

General Notes:

- See Architects drawings for site levels, setbacks and extent of cut and fill.
- This plan shall be read in conjunction with the Hydraulic Engineers drawings.
- All relevant australian standards are to be adhered to.
- Any structural items are to be installed as per the manufacturer/engineers specifications.
- This plan is indicative only and not for construction purposes

SITE CALCULATIONS

| LOT AREA | 305.9 sq m | |
|-----------------------|------------|---------|
| LANDSCAPED AREA TOTAL | 110.9 sq m | 36.249% |

[Click Here to View Our Plant Profiles!](#)

Client: **Mr Herbert & Ms Grimshaw**

Client Signatures:

-
-

Job No. **210140**

Drawing: **Plant List/Specification**

Address: **Lot 16 No.18 Baz Retreat Warriewood**

Council/Lodgement:
Northern Beaches

DappleDesigns

Ph: 1300 DAPPLE
(1300 327753)
E: info@dappledesigns.com.au
www.dappledesigns.com.au

[Click Here to View Our Plant Profiles!](#)

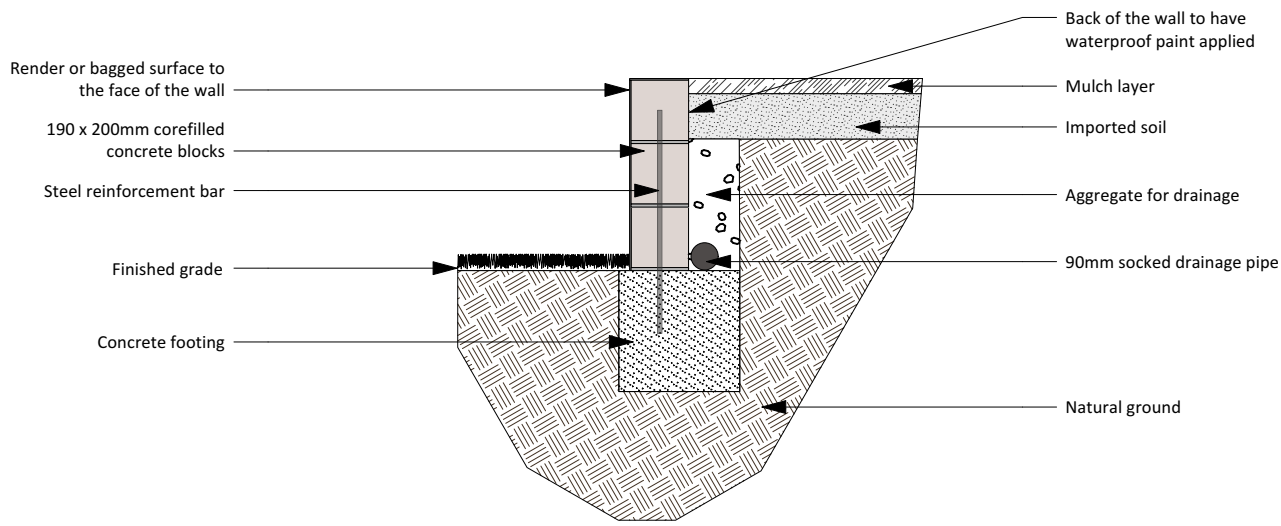

DETAILS

1. ENSURE THAT THERE IS ADEQUATE DRAINAGE BEHIND THE WALL
2. WALL IS TO BE STAIGHT
3. REFER TO PLAN FOR HEIGHTS
4. REFER TO ENGINEERS PLANS FOR WALLS OVER EXEMPT & COMPLYING DEVELOPMENT HEIGHTS

RENDERED/BAGGED RETAINING WALL DETAIL

SCALE 1:25

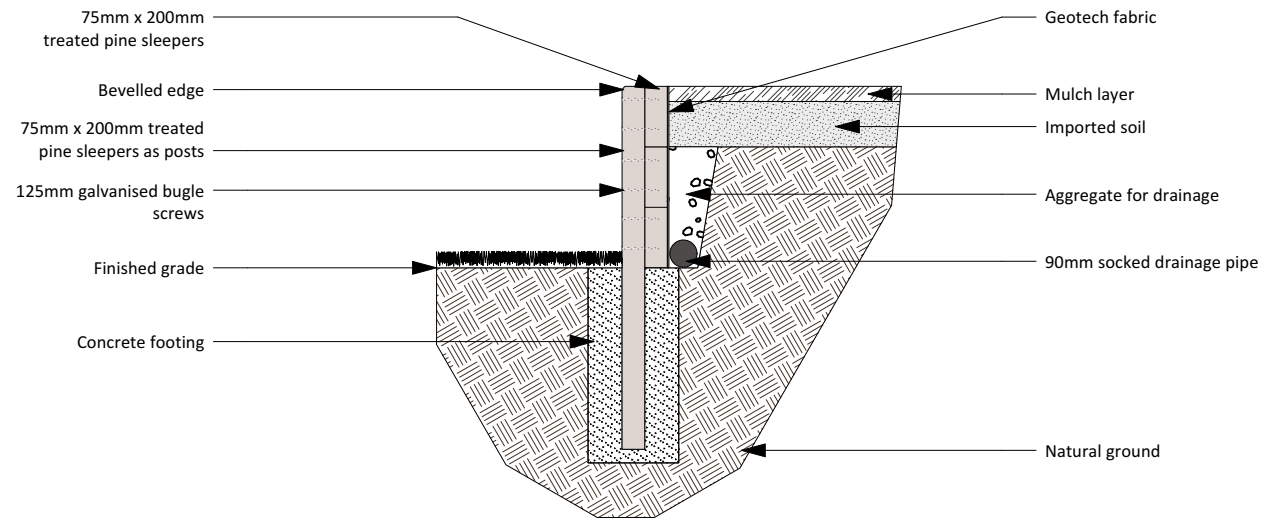

DETAILS

1. ENSURE THAT THERE IS ADEQUATE DRAINAGE BEHIND THE WALL
2. WALL IS TO BE STAIGHT OR SLIGHTLY SLANTED TOWARDS THE SOIL BEING RETAINED
3. TIMBER IS TO BE FREE OF CRACKS AND KNOTS
4. REFER TO PLAN FOR HEIGHTS
5. REFER TO ENGINEERS PLANS FOR WALLS OVER EXEMPT & COMPLYING DEVELOPMENT HEIGHTS

TREATED TIMBER RETAINING WALL DETAIL

SCALE 1:25

TOP VIEW

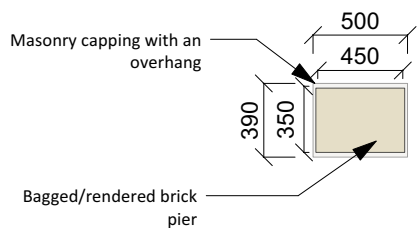

FRONT VIEW

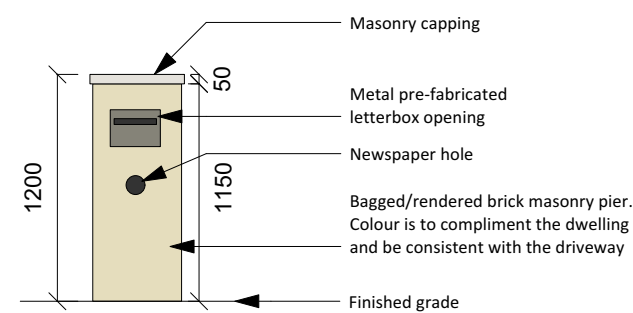

DETAILS

1. COLOUR CHOSEN IS TO COMPLIMENT THE DWELLING
2. ENSURE THAT NO CEMENT OR RENDER IS LEFT ON THE BRICKWORK OR LETTERBOX OPENING
3. BRICK PIER IS TO LEVEL AND STRAIGHT

LETTERBOX DETAIL

SCALE 1:40

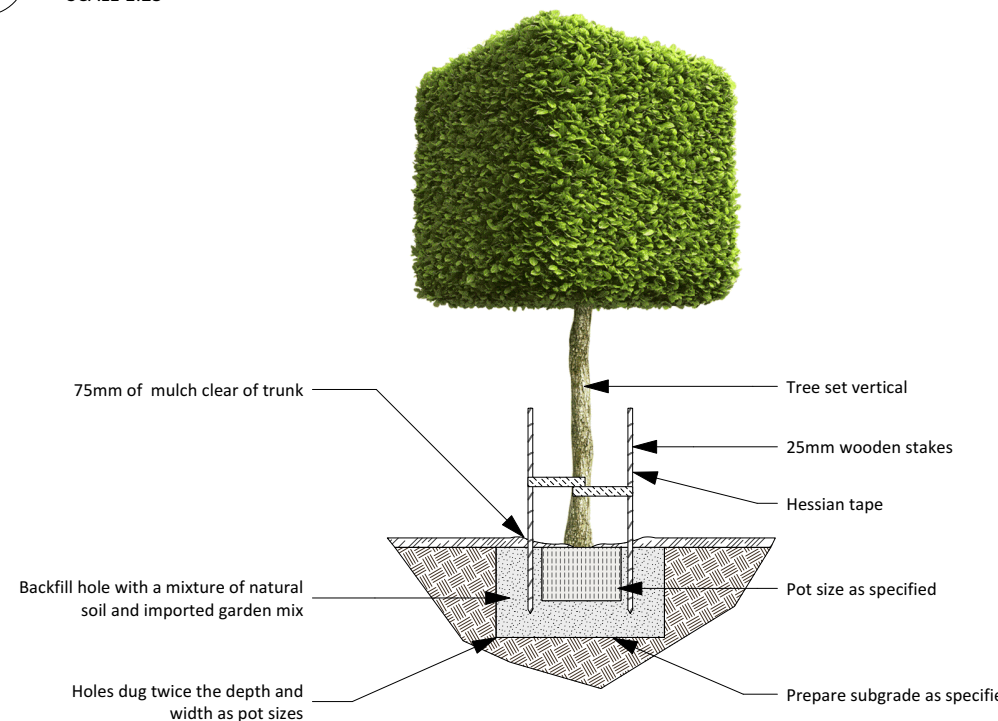

DETAILS

1. SPECIMENS ARE TO BE IN GOOD HEALTH AND FREE FROM PESTS AND DISEASES
2. WATER THOROUGHLY AFTER PLANTING

TREE PLANTING DETAIL

SCALE 1:40

Revision Schedule

| Issue: | Description: | By: | Date: |
|--------|-----------------|-----|----------|
| A | Submission Plan | OS | 20/04/21 |
| A | Submission Plan | OS | 20/04/21 |

| | |
|----------|--------------|
| Drafted: | Scale: 1:200 |
| JS | 0 0 1 2 3 M |
| Sheet: | Reference: |
| 3 of 4 | LP 01 |

Designed by:
Julian Saw
 Diploma of Horticulture
 (Landscape Design)

- General Notes:
1. See Architects drawings for site levels, setbacks and extent of cut and fill.
 2. This plan shall be read in conjunction with the Hydraulic Engineers drawings.
 3. All relevant Australian standards are to be adhered to.
 4. Any structural items are to be installed as per the manufacturer/engineers specifications.
 5. This plan is indicative only and not for construction purposes

| SITE CALCULATIONS | | |
|-----------------------|------------|---------|
| LOT AREA | 305.9 sq m | |
| LANDSCAPED AREA TOTAL | 110.9 sq m | 36.249% |

[Click Here to View Our Plant Profiles!](#)

Client: **Mr Herbert & Ms Grimshaw**

Client Signatures:

- 1.
- 2.

Job No. **210140**

Drawing: **Details**

Address: **Lot 16 No.18 Baz Retreat Warriewood**

Council/Lodgement: **Northern Beaches**

DappleDesigns

Ph: 1300 DAPPLE
 (1300 327753)
 E: info@dappledesigns.com.au
 www.dappledesigns.com.au

Revision Schedule

| Issue: | Description: | By: | Date: |
|--------|-----------------|-----|----------|
| A | Submission Plan | OS | 20/04/21 |
| A | Submission Plan | OS | 20/04/21 |
| | | | |

| | |
|----------------|---|
| Drafted: JS | Scale: 1:200  |
|----------------|---|

| | |
|------------------|---------------------|
| Sheet: 4 of 4 | Reference: LP 01 |
|------------------|---------------------|

Designed by:
Julian Saw
Diploma of Horticulture
(Landscape Design)

- General Notes:
1. See Architects drawings for site levels, setbacks and extent of cut and fill.
 2. This plan shall be read in conjunction with the Hydraulic Engineers drawings.
 3. All relevant Australian standards are to be adhered to.
 4. Any structural items are to be installed as per the manufacturer/engineers specifications.
 5. This plan is indicative only and not for construction purposes

| SITE CALCULATIONS | | |
|-----------------------|------------|---------|
| LOT AREA | 305.9 sq m | |
| LANDSCAPED AREA TOTAL | 110.9 sq m | 36.249% |

[Click Here to View Our Plant Profiles!](#)

Client: **Mr Herbert & Ms Grimshaw**

Client Signatures:
1.
2.

Job No. **210140**

Drawing: **Details**

Address: **Lot 16 No.18 Baz Retreat Warriewood**

Council/Lodgement: **Northern Beaches**

DappleDesigns
Ph: 1300 DAPPLE
(1300 327753)
E: info@dappledesigns.com.au
www.dappledesigns.com.au

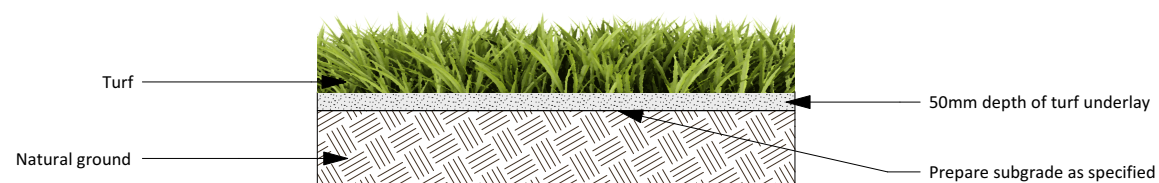

- DETAILS
1. TURF ROLLS ARE TO BE IN GOOD HEALTH, FREE FROM PESTS AND DISEASES AND WITHOUT HOLES
 2. APPLY WATER SAVING CRYSTALS TO THE GROUND PRIOR TO LAYING
 3. BUT ROLLS CLOSELY TOGETHER TO AVOID GAPS AND DIEBACK
 4. WATER THOROUGHLY AFTER PLANTING AND REGULARLY UNTIL ESTABLISHED

TURF LAYING DETAIL
SCALE 1:20

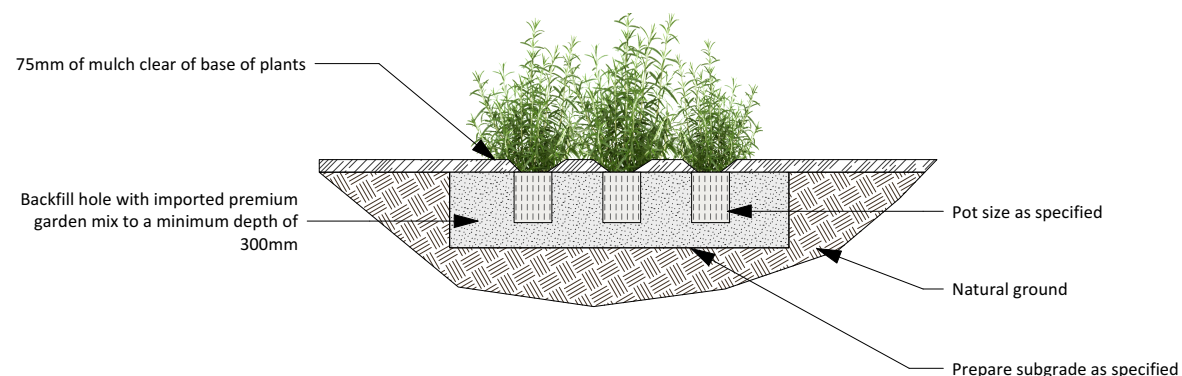

- DETAILS
1. SPECIMENS ARE TO BE IN GOOD HEALTH AND FREE FROM PESTS AND DISEASES
 2. GENTLY LOOSEN ROOTS IF REQUIRED, PRIOR TO PLANTING
 3. WATER THOROUGHLY AFTER PLANTING
 4. REFER TO PLAN FOR QUANTITIES AND SPACING

SHRUB & GROUNDCOVER PLANTING DETAIL
SCALE 1:30