

Technical specifications

Width 1000 - 2200 mm.

Height Five standard heights:
 - 800/1300 mm (lowered position/raised position)
 - 900/1500 mm
 - 1000/1700 mm
 - 1100/1900 mm
 - 1200/2100 mm (max width 2000 mm)

Thickness 90 mm.

Width vertical profiles 31 mm.

Height horizontal profiles 15 mm.

Operation: Manual or electrical operation.

Glass 5 mm laminated glass in the moving part.
 The lower fixed part is supplied with 6 mm laminated glass in standard performance but can be supplied with other materials such as aluminium or wood.

Surface coating Satin anodized aluminium in standard performance. Others surface coatings are available at an additional cost, such as powder coating wet painting or anodizing in other colours.

Some of the details of the profiles shown in the drawing are omitted.

Svalson AB reserve the rights to make product changes without prior notice. This drawing is indicative only and may differ from the actual product delivered.

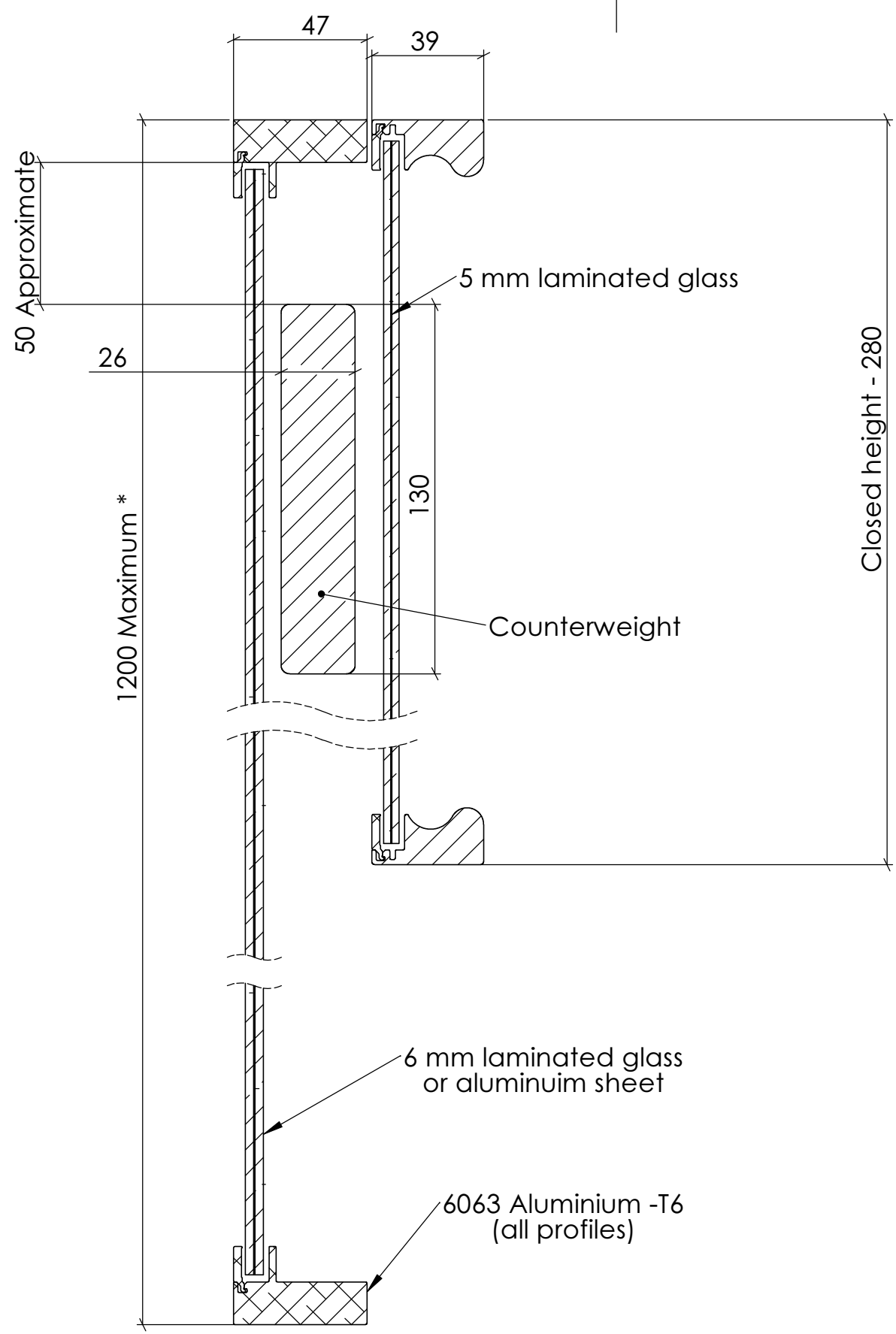

F-F

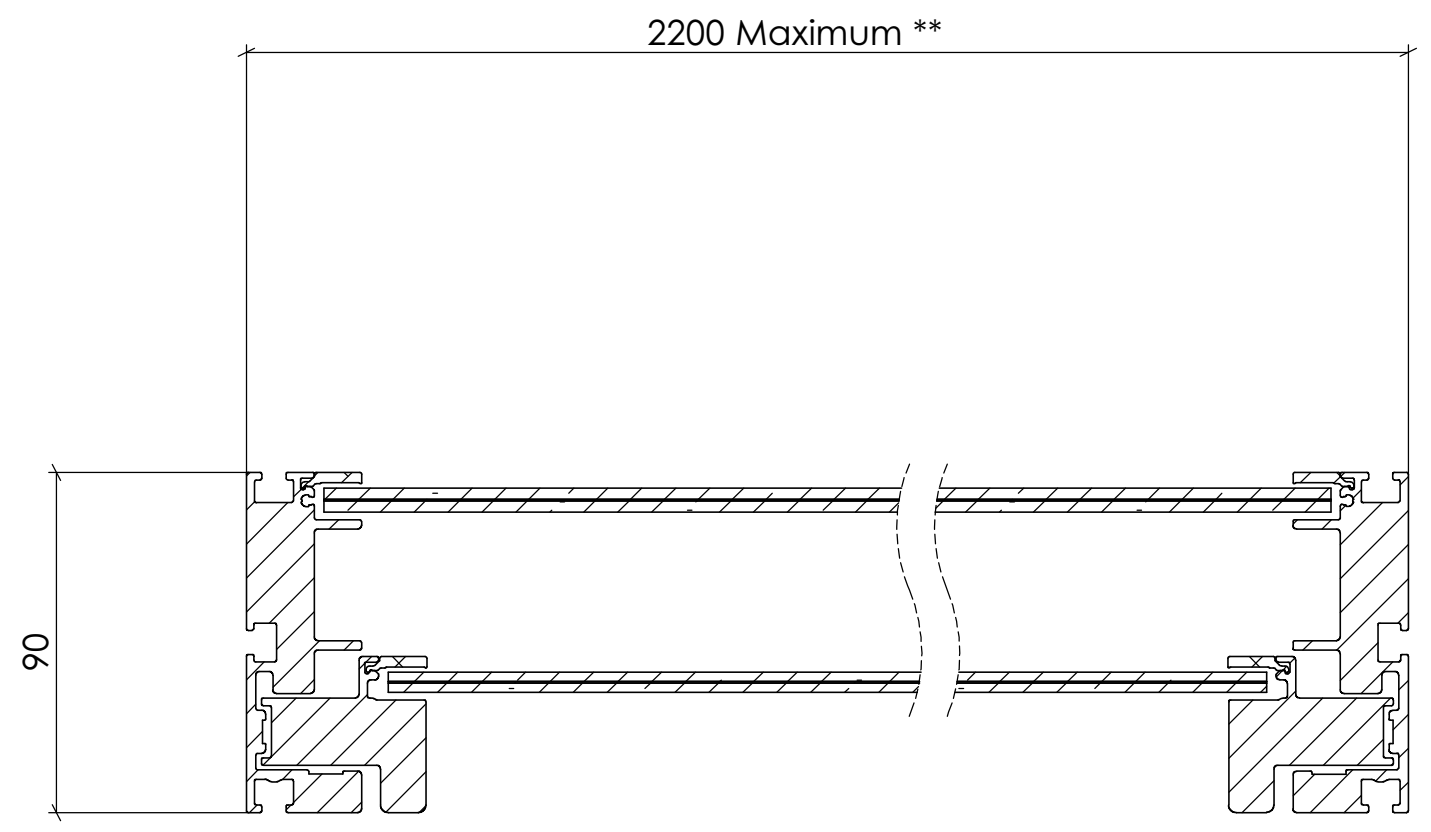

G-G

* Café au Lâ has a maximum closed height of 1100 when the width exceeds 2000
 ** Café au Lâ has a maximum width of 2000 when the closed height is 1200

Telephone: +46 911 66725
<http://www.svalson.com>

Title Cross section drawing		View Placement 	
Product Café au Lâ	View from outside <input checked="" type="checkbox"/>	Drawn/Design CM	Scale 1:2
Date 080318	View from inside <input type="checkbox"/>	Rev. 04	Sheet 2 (4)
Drawing Number 14.GC			

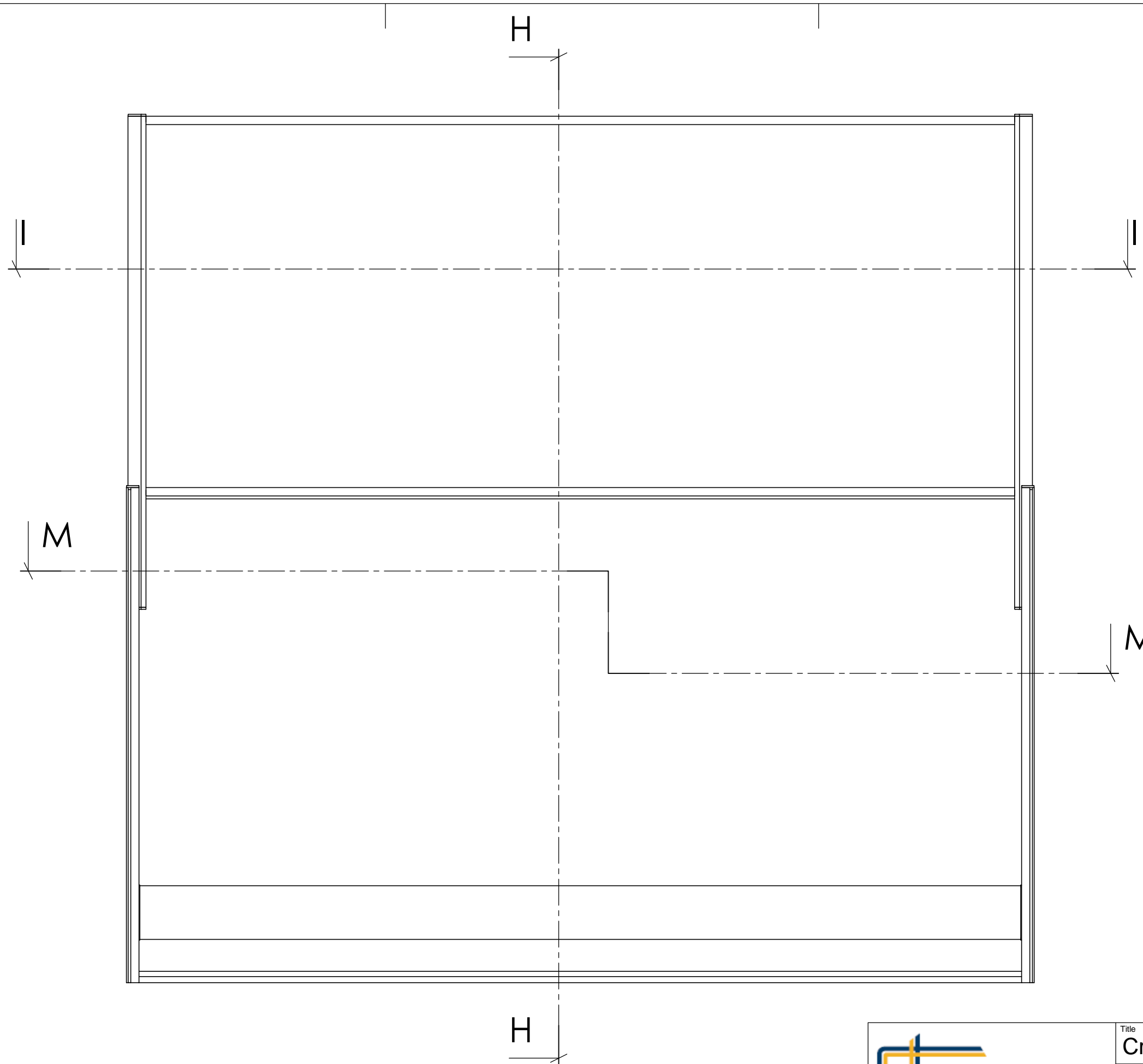

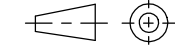

Telephone: +46 911 66725
<http://www.svalson.com>

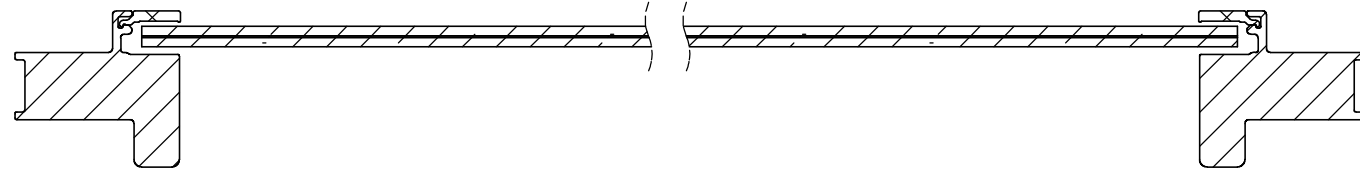
Title Cross section drawing		View Placement 	
Product Café au Lä	View from outside <input checked="" type="checkbox"/>	Drawn/Design CM	Scale 1:10
Date 080318	View from inside <input type="checkbox"/>	Rev. 04	Sheet 3 (4)
Drawing Number 14.GC			

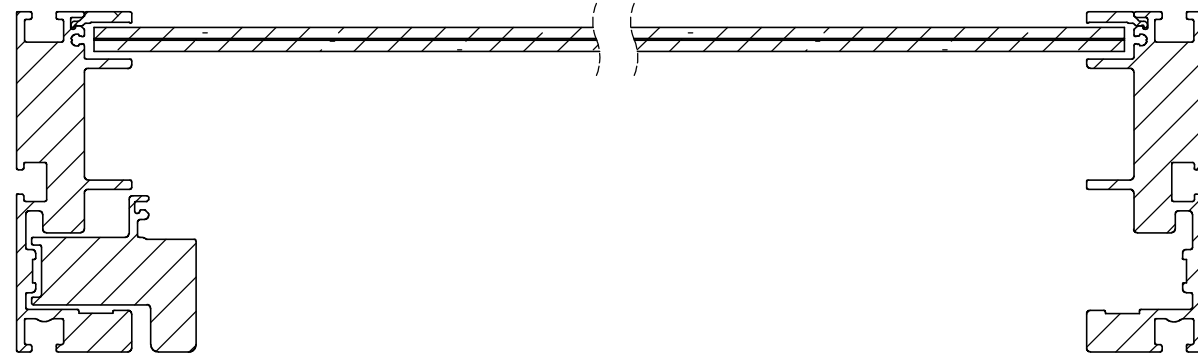

I-I



M-M

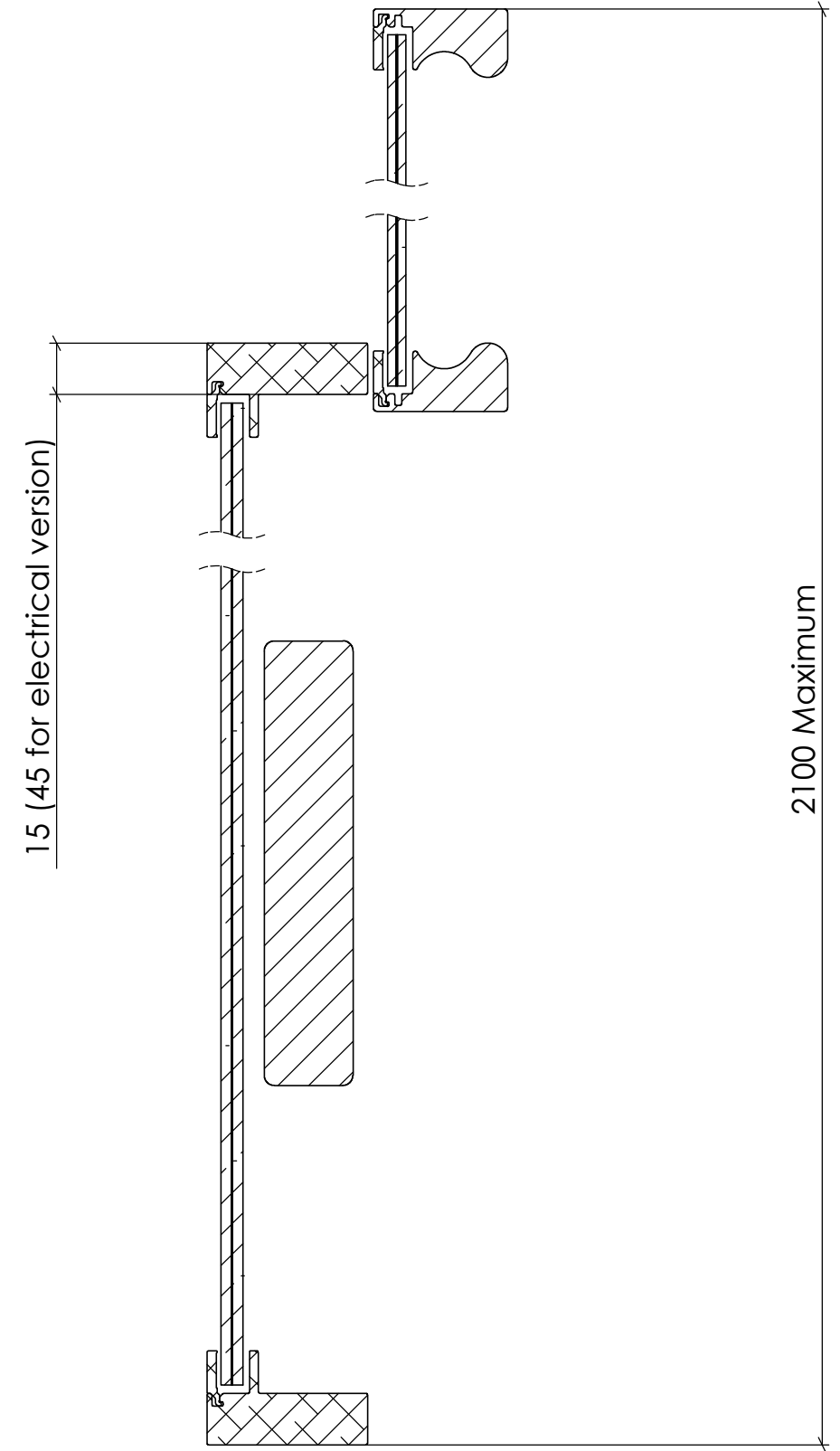

H-H

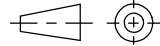

Telephone: +46 911 66725
<http://www.svalson.com>

Title Cross section drawing		View Placement 	
Product Café au Lä	View from outside <input checked="" type="checkbox"/>	Drawn/Design CM	Scale 1:2
Date 080318	View from inside <input type="checkbox"/>	Rev. 04	Sheet 4 (4)
Drawing Number 14.GC			

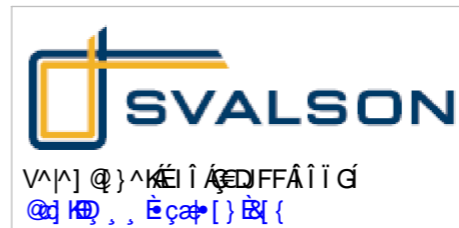
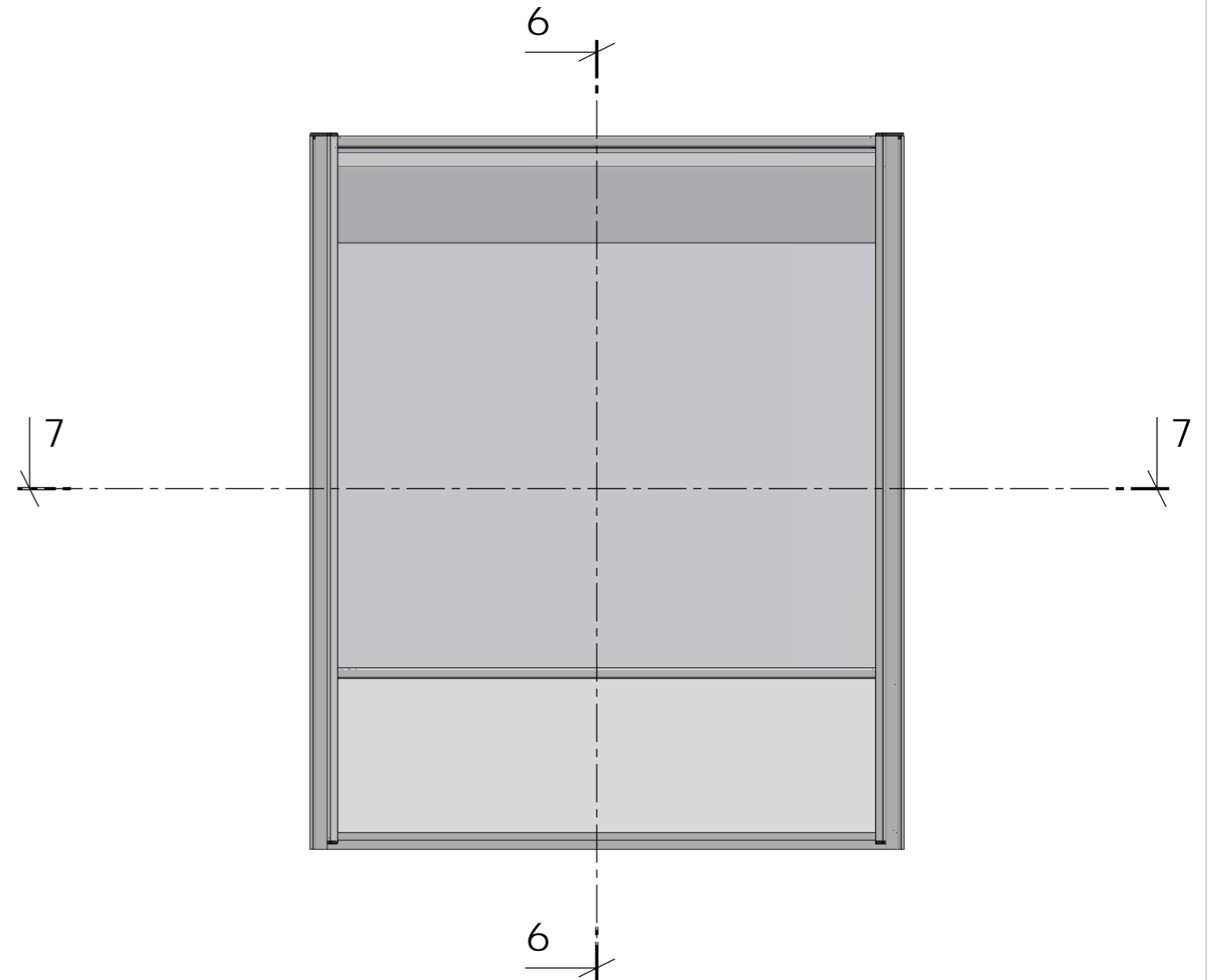
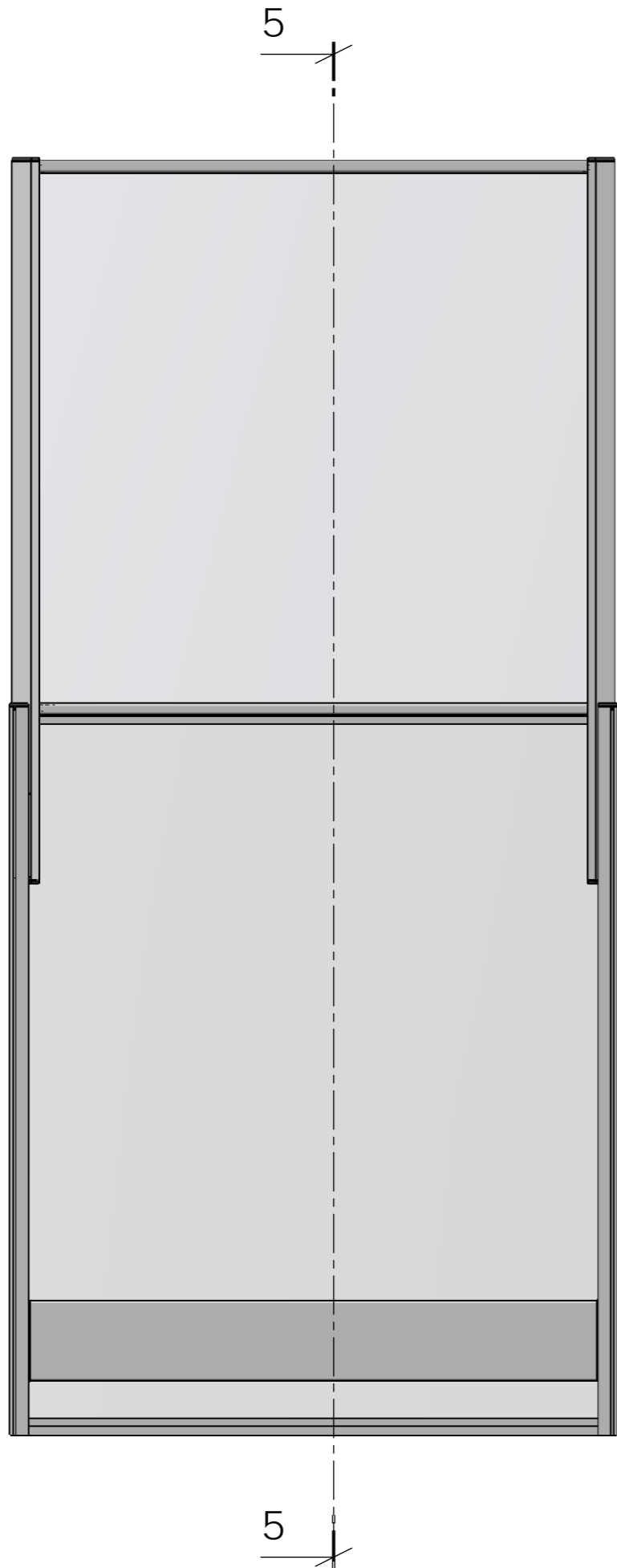

Văn	Y æ ! Á ^ • ã c a a Á [] B ã à a a ^	Xã, Á [a a (^) c
Ú [á ' & c	Ô æ . Æ / S ê	Ô a a } B a a } Ú a a ^
Ô a a ^	Ô a a a ^ a ^ { a ^	Ô T F K €
F E F E G G	S ê G Ë Ë Ë Ë Ë	Ú a a É Ú a a c
		€ É F Á D

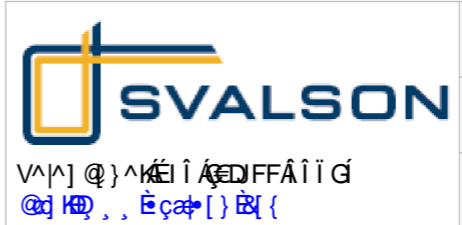
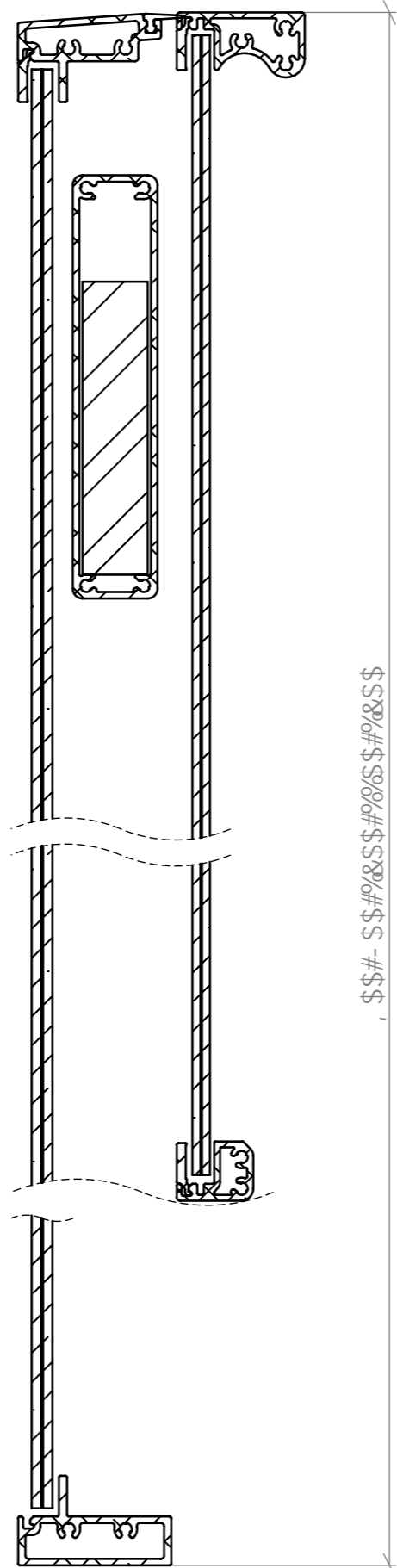
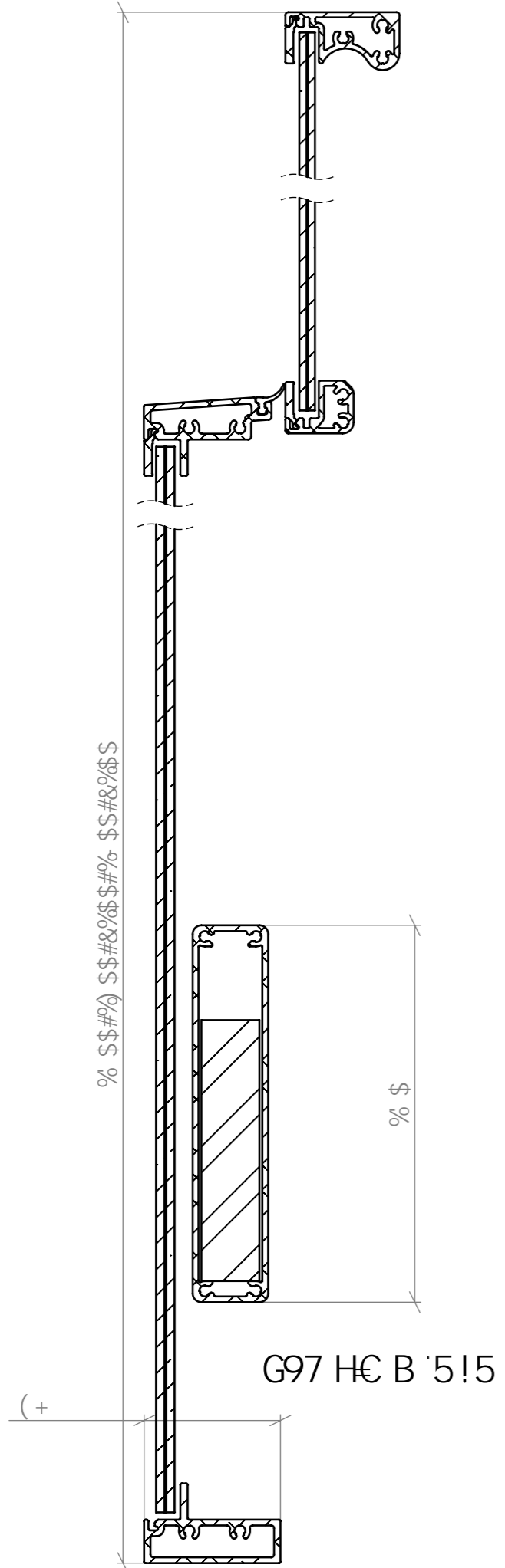

Vã^	Y æ^!Á^•ã çã óã àÁ[] } È ã àæ	Xã, Á æ^ (^) c
Ù á' &c	Ôæ: Áě Áš	Ô ã } ð^•ã } Û&æ^
Ôæ^	F€F€GG Šê GÈÙÈÙÈÈ	Ô^çÈ
Ù ã		Ù@^c
		€É GÇD

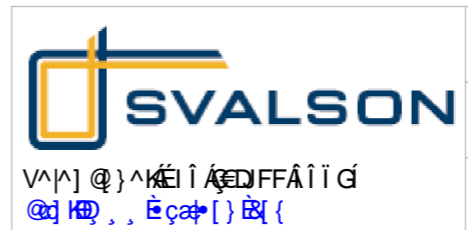
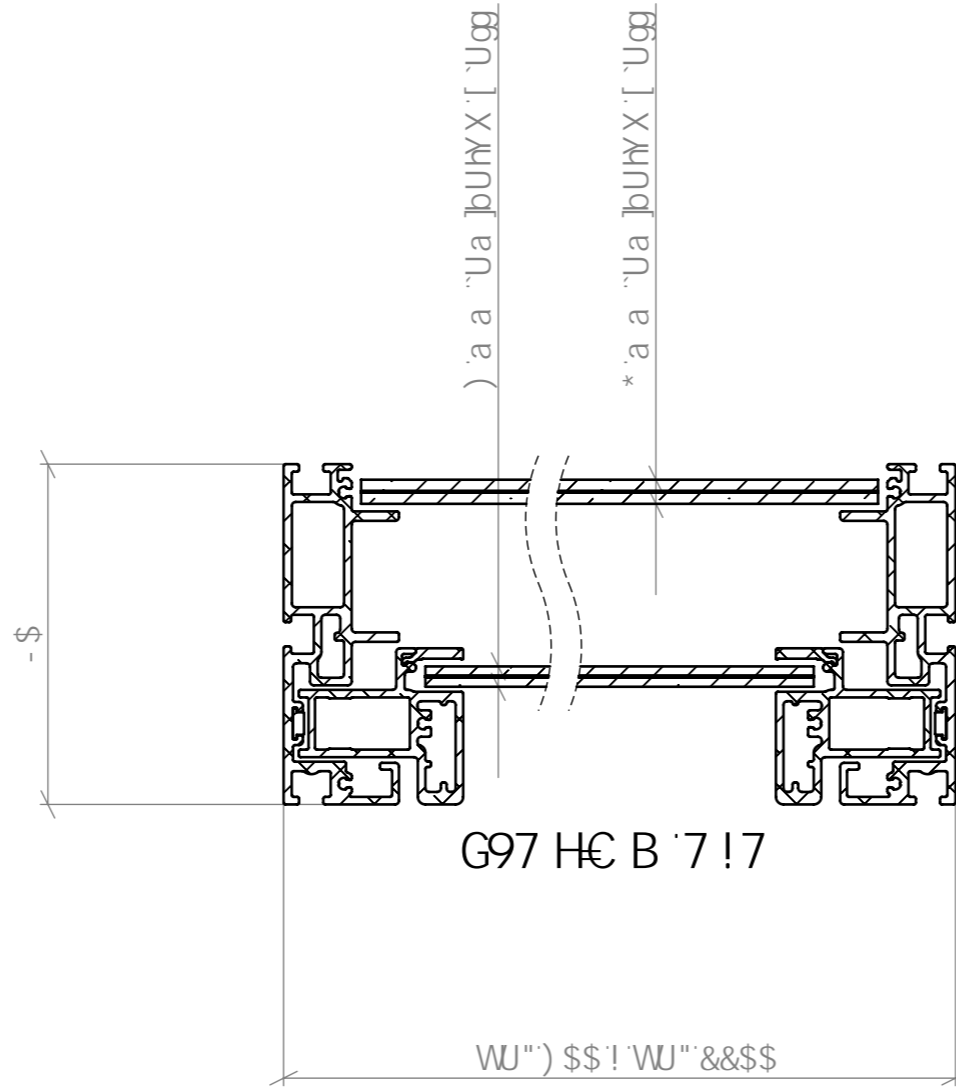

Väp^	Y æ^ ! Á^ • ã ç ç á Á [] È] ä à æ ^	Xä, Ä] æ ^ (^) c	
Ü [ä' &c	Ôæ: Äæ ÄÛ	Xä, Ä [(Ä' • ä^	Ö ä ç } ä^ • ä } Ü æ x^
Ö æ x^	F E F E G G	Xä, Ä [(Ä • ä^	Ô T F I G
	Š è G È Ù È Ù È Ù		Ü ^ ç È Ü @ ^ c
			€ É H Ç D