

Note:
Landscape Contractor shall undertake minor earthworks after handover by builder as required to achieve maximum gradient to all lawn and mulched areas of 1:50, and 1:4 to all garden areas. Should retaining walls be required to achieve these falls they shall be designed by an engineer and be a maximum height compliant with council and/or developer policies.

PLANTING SCHEDULE (ENTIRE PROJECT)

Latin Name	Common Name	Quantity	Scheduled Size	Spread	Height
Archontophoenix cunninghamiana	Bangalow Palm	2	45lt	3500	8000
Banksia integrifolia	Coastal Banksia	1	45lt	4000	9000
Doryanthes excelsa	Gynea Lily	4	250mm	1200	1500
Juniperus conferta	Shore Juniper	23	250mm	1200	500
Lomandra longifolia	Native Grass	36	200mm	700	700
Philodendron 'Xanadu'	Dwarf Philodendron	51	200mm	600	800
Rhapis excelsa	Purple Leaved Prunus	4	300mm	1200	2000
Westringia 'Jervis Gem'	Coastal Rosemary	6	250mm	1000	1000

Table 5 Minimum soil standards for plant types and sizes

Plant type	Definition	Soil volume	Soil depth	Soil area
Large trees	12-18m high, up to 16m crown spread at maturity	150m³	1,200mm	10m x 10m or equivalent
Medium trees	8-12m high, up to 8m crown spread at maturity	35m³	1,000mm	6m x 6m or equivalent
Small trees	6-8m high, up to 4m crown spread at maturity	9m³	800mm	3.5m x 3.5m or equivalent
Shrubs			500-600mm	
Ground cover			300-450mm	
Turf			200mm	

Note: The above has been calculated assuming fortnightly irrigation. Any sub-surface drainage requirements are in addition to the above minimum soil depths

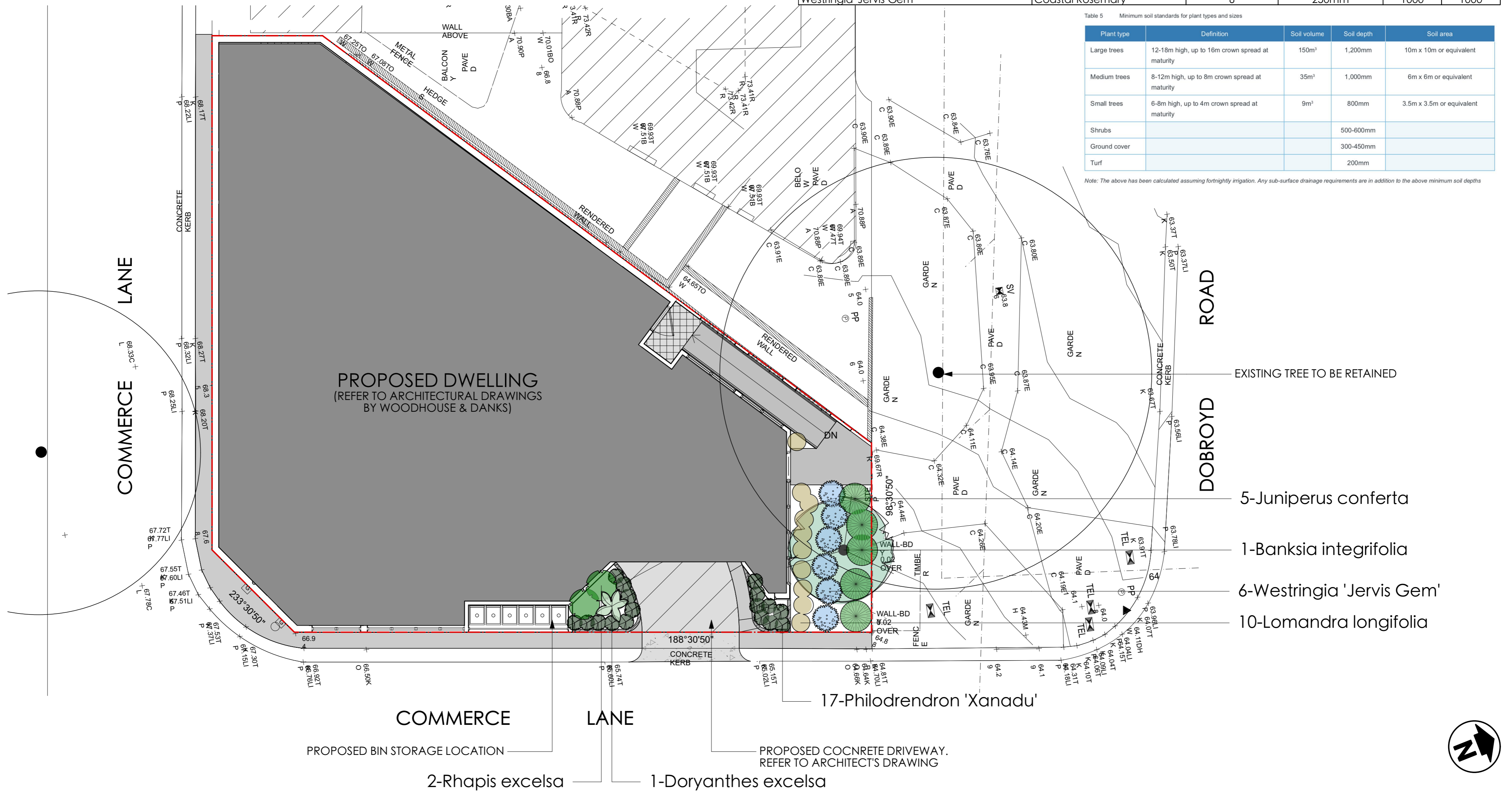

Legend

	PROPOSED PAVED AREA
	PROPOSED ARTIFICIAL TURF AREA
	PROPOSED CONCRETE PATH
	PROPOSED CONCRETE DRIVEWAY. REFER TO ARCHITECT'S DRAWING
	PROPOSED TIMBER DECKING AREA.

	T/E TIMBER LAWN EDGE
	SITE BOUNDARY
	EXISTING TREE TO BE RETAINED
	EXISTING TREE TO BE REMOVED

Architect

WOODHOUSE & DANKS ARCHITECTS PTY LTD
 Stephen R Fayle
 Suite 207 - Level 2, 20 Dale Street, Brookvale, NSW 2100
 T: (02) 9939 8810 F: (02) 9939 8830
 E: admin@woodhousedanks.com.au

- Notes
- All dimensions and levels shall be verified by Contractor on site prior to commencement of work.
 - All detailing of drainage to paved areas shall be by others.
 - All levels shall be determined by others and approved on site by client.
 - Extent, height and position of all retaining walls shall be determined by others and approved on site by client, to Structural Engineers detail.
 - Do not scale from drawings.
 - If in doubt contact the Landscape Architect.
 - All boundaries shall be surveyed prior to commencement of construction works.
 - This plan is for DA purposes only. It has not been detailed for construction.
 - All dimensions, levels and boundaries are nominal only.
 - This design shall not be copied, utilised or reproduced in any way without prior written permission of A Total Concept Landscape Architects.

Revision	Description	Date

DATE 20/01/22

DRAWING **PROPOSED GROUND FLOOR LANDSCAPE PLAN**

ADDRESS 29 DOBROYD ROAD, BALGOWLAH

CLIENT **WOODHOUSE & DANK ARCHITECTS**

A Total Concept Landscape Architects & Swimming Pool Designers
 65 West Street, North Sydney NSW 2060
 Tel: (02) 9957 5122 Fax: (02) 9957 5922

PROJECT # WOODHOUSE & DANK ARCHITECTS
 DWG # L/01

DRAWN OC
 CHECK JC

atc
 a total concept
 landscape architects & swimming pool designers



Note:
Landscape Contractor shall undertake minor earthworks after handover by builder as required to achieve maximum gradient to all lawn and mulched areas of 1:50, and 1:4 to all garden areas. Should retaining walls be required to achieve these falls they shall be designed by an engineer and be a maximum height compliant with council and/or developer policies.

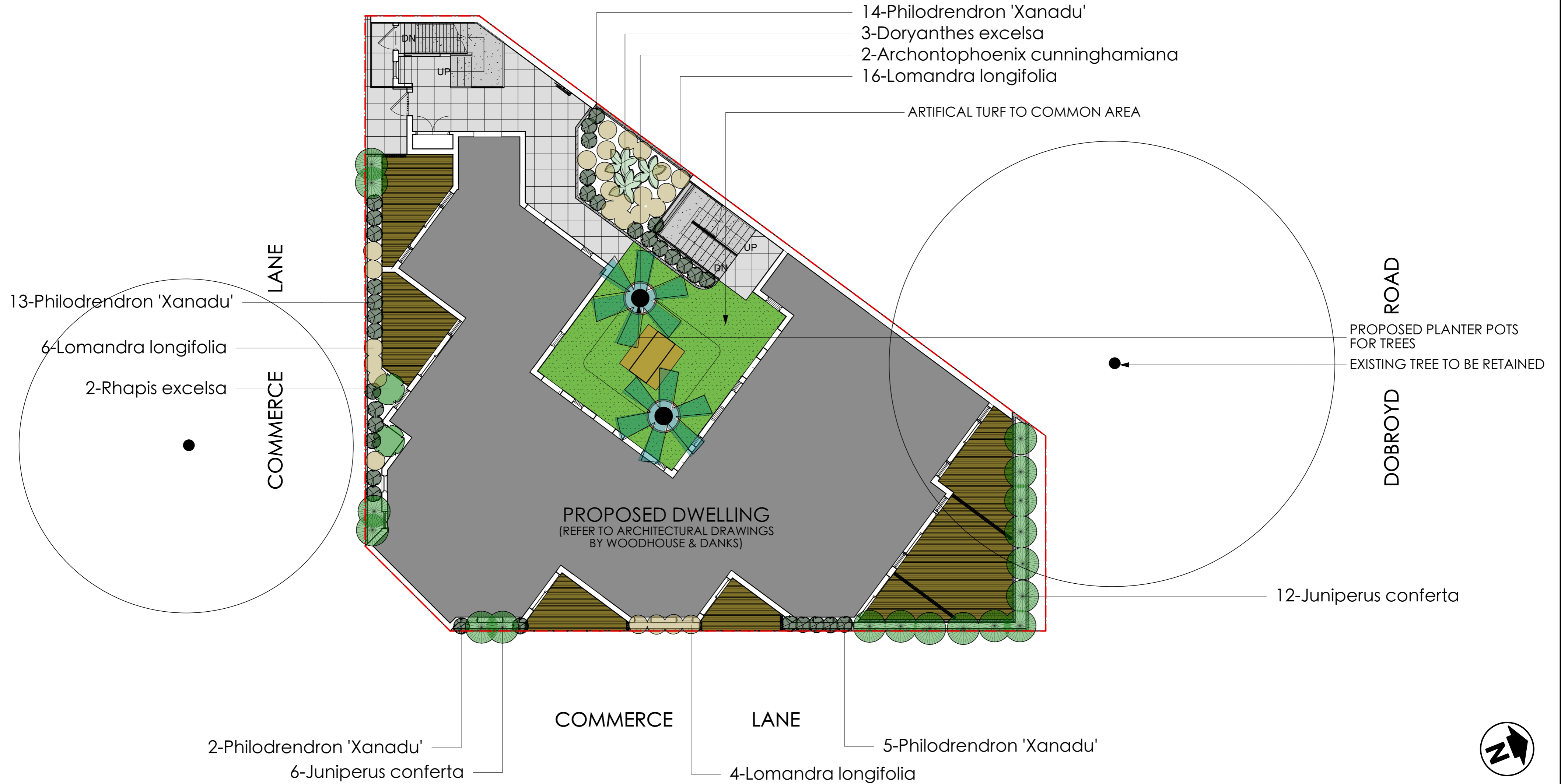

Legend

	PROPOSED PAVED AREA
	PROPOSED ARTIFICIAL TURF AREA
	PROPOSED CONCRETE PATH
	PROPOSED CONCRETE DRIVEWAY. REFER TO ARCHITECTS DRAWING
	PROPOSED TIMBER DECKING AREA.

	T/E	TIMBER LAWN EDGE
		SITE BOUNDARY
		EXISTING TREE TO BE RETAINED
		EXISTING TREE TO BE REMOVED

Architect

WOODHOUSE & DANKS PTY LTD
ARCHITECTS
Stephen R Fayle
ABN: 26 064 690 106
ARN: 3274
Suite 207 - Level 2, 20 Dale Street, Brookvale, NSW 2100
T: (02) 9939 8810 F: (02) 9939 8830
E: admin@woodhousedanks.com.au

Notes

- All dimensions and levels shall be verified by Contractor on site prior to commencement of work.
- All detailing of drainage to paved areas shall be by others.
- All levels shall be determined by others and approved on site by client.
- Extent, height and position of all retaining walls shall be determined by others and approved on site by client, to Structural Engineers detail.
- Do not scale from drawings.
- If in doubt contact the Landscape Architect.
- All boundaries shall be surveyed prior to commencement of construction works.
- This plan is for DA purposes only. It has not been detailed for construction.
- All dimensions, levels and boundaries are nominal only.
- This design shall not be copied, utilised or reproduced in any way without prior written permission of A Total Concept Landscape Architects.

Revision	Description	Date

DATE DRAWING	20/01/22	PROJECT #	WOODHOUSE & DANK ARCHITECTS
ADDRESS	29 DOBROYD ROAD, BALGOWLAH	DWG #	L/02
CLIENT	WOODHOUSE & DANK ARCHITECTS	DATE #	20/01/22
		SCALE # A2	1:100
		DRAWN	OC
		CHKD	JC
A Total Concept Landscape Architects & Swimming Pool Designers 65 West Street, North Sydney NSW 2060 Tel: (02) 9957 5122 Fx: (02) 9957 5922			



Note:
Landscape Contractor shall undertake minor earthworks after handover by builder as required to achieve maximum gradient to all lawn and mulched areas of 1:50, and 1:4 to all garden areas. Should retaining walls be required to achieve these falls they shall be designed by an engineer and be a maximum height compliant with council and/or developer policies.



Legend

	PROPOSED PAVED AREA
	PROPOSED ARTIFICIAL TURF AREA
	PROPOSED CONCRETE PATH
	PROPOSED CONCRETE DRIVEWAY. REFER TO ARCHITECTS DRAWING
	PROPOSED TIMBER DECKING AREA.

	T/E	TIMBER LAWN EDGE
		SITE BOUNDARY
		EXISTING TREE TO BE RETAINED
		EXISTING TREE TO BE REMOVED

Architect

WOODHOUSE & DANKS PTY LTD
ARCHITECTS
Stephen R Fayle
Suite 207 - Level 2, 20 Dale Street, Brookvale, NSW 2100
T: (02) 9939 8810 F: (02) 9939 8830
E: admin@woodhousedanks.com.au

ABN: 26 064 690 106
ARN: 3274

Notes

- All dimensions and levels shall be verified by Contractor on site prior to commencement of work.
- All detailing of drainage to paved areas shall be by others.
- All levels shall be determined by others and approved on site by client.
- Extent, height and position of all retaining walls shall be determined by others and approved on site by client, to Structural Engineers detail.
- Do not scale from drawings.
- If in doubt contact the Landscape Architect.
- All boundaries shall be surveyed prior to commencement of construction works.
- This plan is for DA purposes only. It has not been detailed for construction.
- All dimensions, levels and boundaries are nominal only.
- This design shall not be copied, utilised or reproduced in any way without prior written permission of A Total Concept Landscape Architects.

Revision	Description	Date

DATE	REVISION
DRAWING	PROPOSED LEVEL 2 LANDSCAPE PLAN
ADDRESS	29 DOBROYD ROAD, BALGOWLAH
CLIENT	WOODHOUSE & DANK ARCHITECTS
A Total Concept Landscape Architects & Swimming Pool Designers 65 West Street, North Sydney NSW 2060 Tel: (02) 9957 5122 Fx: (02) 9957 5922	
DATE #	20/01/22
SCALE @ A2	1:100
DRAWN	OC
CHKD	JC
REVISION	

PROJECT # WOODHOUSE & DANK ARCHITECTS
DWG # L/03

atc
a total concept
landscape architects & swimming pool designers

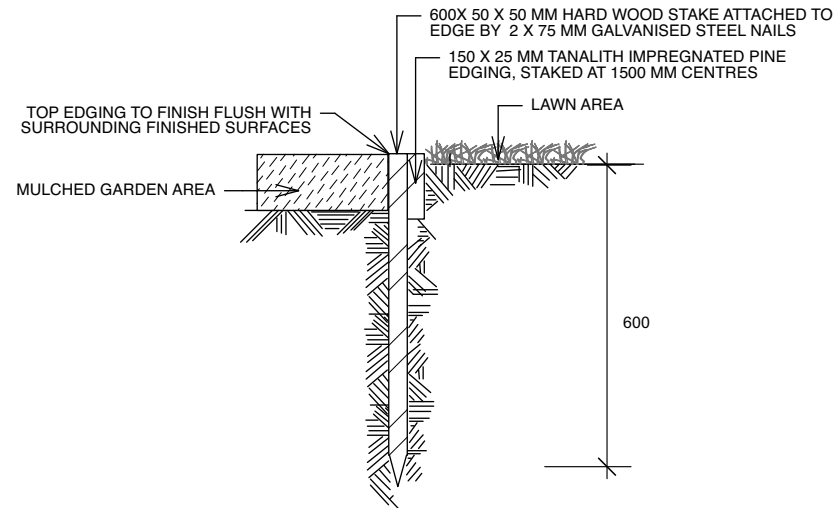

TYPICAL TIMBER EDGE DETAIL
SCALE 1:10
DO NOT SCALE

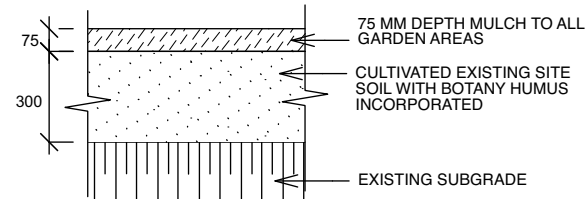

SOIL TO GARDEN AREAS
SCALE 1:20

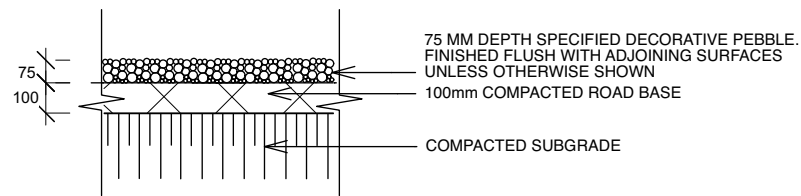

PEBBLE PATHWAY
SCALE 1:10

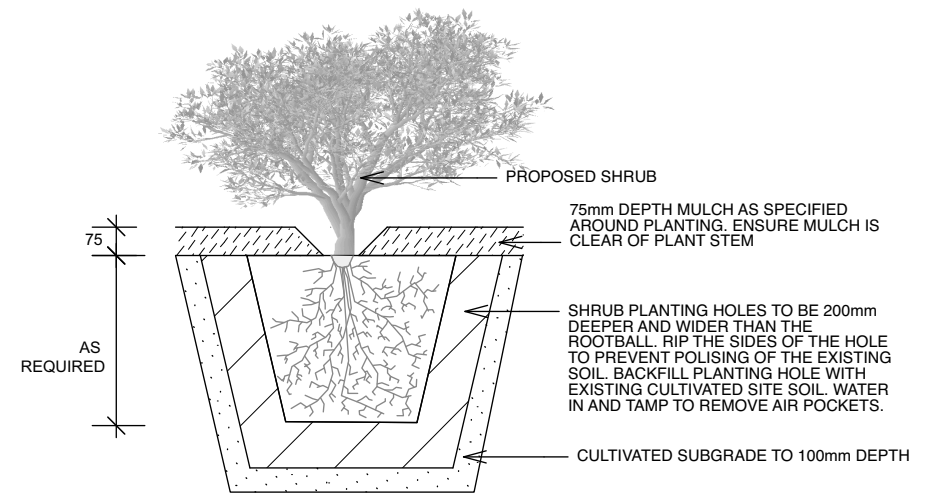

PLANTING DETAIL
SCALE 1:20

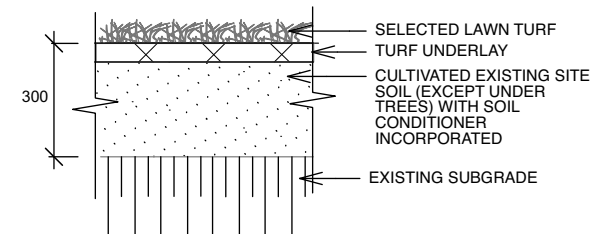

TYPICAL TURF DETAIL
SCALE 1:20

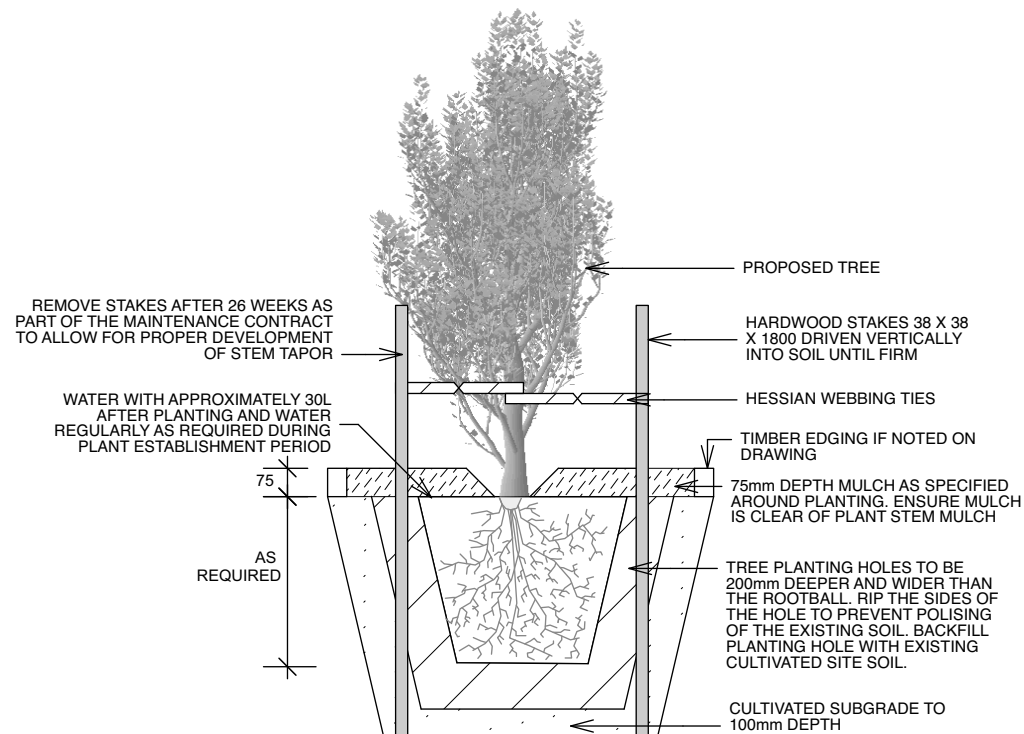

TREE PLANTING & STAKING DETAIL
SCALE 1:20

- Notes:**
1. All dimensions and levels shall be verified by Contractor on site prior to commencement of work.
 2. All detailing of drainage to paved areas shall be by others.
 3. All levels shall be determined by others and approved on site by client.
 4. Extent, height and position of all retaining walls shall be determined by others and approved on site by client.
 5. Do not scale from drawings.
 6. If in doubt contact the Landscape Architect.
 7. All boundaries shall be surveyed prior to commencement of construction works.
 8. This plan is for DA purposes only. It has not been detailed for construction.
 9. All dimensions, levels and boundaries are nominal only.
 10. This design shall not be copied, utilised or reproduced in any way without prior written permission of A Total Concept Landscape Architects.

DATE	REVISION		
DRAWING		LANDSCAPE DETAILS	
ADDRESS		29 DOBROYD ROAD, BALGOWLAH	
CLIENT	WOODHOUSE & DANKS ARCHITECTS	PROJECT #	WOODHOUSE & DANK ARCHITECTS
		DATE #	20/01/22
		SCALE @ A3 AS SHOWN	L/03
A Total Concept Landscape Architects & Swimming Pool Designers 65 West Street, North Sydney NSW 2060 Tel: (02) 9957 5122 Fx: (02) 9957 5922		DRAWN	OC
CHKD	JC	REVISION	

OUTLINE LANDSCAPE SPECIFICATION

Preparation by Builder: Builder shall remove all existing concrete pathways, fences, footings, walls etc. not notated to be retained and complete all necessary excavation work prior to commencement on site by Landscape Contractor (Contractor). Builder shall also install new retaining walls, kerbs, layback kerb, crossover, pathways etc. and make good all existing kerbs, gutters etc. as necessary and to approval of Council. Builder shall ensure that a minimum 450mm of topsoil in garden areas and a minimum 150mm of topsoil in lawn areas exists. Should required depths not exist Builder shall contact Landscape Architect and ask for instructions prior to completion of excavation works.

Excavate as necessary, then fill with approved site topsoil to allow for minimum 500mm soil depth in garden areas and 150mm soil depth in lawn areas and to gain required shapes & levels. Ensure all garden and lawn areas drain satisfactorily. All levels & surface drainage shall be determined by others & approved on site by Head Contractor. Note: Approved imported topsoil mix may be utilised if there is insufficient site topsoil available. State in Tender a m3 rate for additional imported topsoil and the quantities of both site topsoil and imported topsoil allowed for in Tender.

Initial Preparation: Verify all dimensions & levels on site prior to commencement. Do not scale from drawings. Locate all underground & above ground services & ensure no damage occurs to them throughout contract. Spray approved weedicide to all proposed lawn & garden areas to manufacturer's directions. Remove existing concrete pathways, footings, walls etc. not notated to be retained & weeds from site. Levels indicated on Plan are nominal only and are derived from Architectural Plans & Drawings by others. Final structural integrity of all items shall be the sole responsibility of Landscape Contractor.

Tree Protection: Trees to be retained shall be protected during site works and construction by the erection of solid barricades to the specification of Council. Storage of machinery or materials beneath canopy of trees to be retained shall not be permitted. Changes to soil level and cultivation of soil beneath canopy of trees to be retained shall not be permitted unless under direct supervision of Landscape Architect. Existing trees shall be pruned to Landscape Architects onsite instructions.

Soil Preparation: Cultivate to depth of 300mm all proposed lawn & garden areas incorporating minimum 100mm depth of organic clay breaker into existing site soil. Do not cultivate beneath existing trees to be retained. In areas where fill is required gain required shapes & levels using a premium grade soil mix. In areas where excavation is required (if in clay) over excavate as required to allow for installation of 500mm depth of premium grade topsoil mix to garden areas and 300mm depth of premium grade topsoil mix to lawn areas. Undertake all required action to ensure that no rootballs of proposed plants sit in clay wells and that all garden areas and lawn areas drain satisfactorily. Note it is intended that wherever possible existing levels shall not be altered through garden and lawn areas. It is the Contractors responsibility to ensure that the end result of the project is that all lawn and garden areas drain sufficiently (both surface & subsurface), are at required finished levels and have sufficient soil depths to enable lawn and plants to thrive and grow. Should alternative works to those specified be required to achieve the above result, Contractor shall inform Builder at time of Tender and request instructions.

Lawn Edging and Stepping Stones:(i) 125 x 25mm approved tanalith impregnated pine edging shall be installed, to lines as indicated on plan and staked with approved stakes at maximum 1500mm centres at ends and changes of direction; stakes shall be nailed to edging with approved galvanised steel nails. Top of edging shall finish flush with surrounding surfaces. Top of stakes shall finish 25mm below top of edging. (ii) Contractor shall install approved bricks on edge on a minimum 100mm deep x 90mm wide concrete footing with brick tor set in, to lines nominated on plan as brick edging. Bricks shall be laid with a nominal 10mm wide approved coloured mortar joint. Bricks needing to be cut shall be done so with clean sharp cuts. Top of edging shall finish flush with surrounding finished surfaces. Approved sandstone stepping stones shall be positioned as indicated on plan on a 25mm river sand bed. Approved sandstone stepping stones shall be positioned as indicated on plan on a 25mm river sand bed.

Retaining Walls: Positions, detail and heights of retaining walls shall be by others.

Planting: Purchase plants from an approved nursery. Plants to be healthy & true to type & species. Set out plants to positions indicated on plan. Following approval, plant holes shall be dug approximately twice width and to 100mm deeper than plant rootballs that they are to receive. Base and sides of hole shall be further loosened. Fertiliser, followed by 100mm depth of topsoil mix shall then be placed into base of hole and lightly consolidated. Base of hole shall then be watered. Remove plant container and install plant into hole. Rootball shall be backfilled with surrounding topsoil and topsoil firmed into place. An approved shallow dish shall be formed to contain water around base of stem. Base of stem of plant shall finish flush with finished soil level. Once installed plant shall be thoroughly watered and maintained for the duration of the Contract.

Staking: All trees shall be staked using 2 x 38mm x 38mm x 2000mm long hardwood stakes per plant and with hessian webbing ties installed to Landscape Architect's on site instructions.

Mulching: Install 75mm depth of 25mm diameter hardwood mulch to all garden areas, coving mulch down around all plant stems & to finish flush with adjacent surfaces.

Turfing: Prepare for, level & lay cultivated Palmetto Buffulo turves to all areas nominated on plan as being lawn. Roll, water, fertilise, mow & maintain lawns as necessary until completion of maintenance period. At same time make good all existing lawn areas using same lawn type. Lawns in shade shall be over sown with an approved seed mix. Allow to retrim and returf councils nature strip as required.

Fencing: Retain all existing fences unless advised otherwise by builder. Install timber paling fences to heights indicated on Plan.

Paving: Areas to be paved shall be excavated or filled to allow for installation of bedding materials. Levels and falls shall be as per Plan. Surface drainage on paving shall be towards grated drains with all drains connected to stormwater system and installed by Builder.

Irrigation: Contractor shall supply and install an approved fully automatic, vandal resistant, computerised irrigation system to all garden and lawn areas, excluding council nature strip. Entire system shall be to approval of Water Board and shall utilise pop-up sprinklers and electronic controllers. Contractor shall be responsible to ensure that system is able to satisfactorily operate on available water pressure. Power supply for use by irrigation system shall be provided to an approved location near southwest corner of residence by others and shall consist of an approved weatherproof G.P.O. The irrigation system controller shall be housed in an approved waterproof cabinet mounted to external wall of residence.

Clotheslines: Contractor shall allow for all necessary labour and materials and shall install clotheslines to positions as indicated on plan to manufacturer's instructions to approval of Landscape Architect. Clothesline type shall be equal to 'Hills Foldaline'.

Completion: Prior to practical completion remove from site all unwanted debris occurring from work. Satisfy Council that all landscaping work has been undertaken in strict accordance with Councils landscape codes & guidelines.

Maintenance Period: A twelve month maintenance period shall be undertaken by owner or owners representative as set out herein. Owner shall have care and maintenance of all work specified under this Contract and shall rectify any defective work for a period of 52 weeks following Practical Completion of Landscape Works. This period shall be herein known as the Maintenance Period. Work shall also include for the care and maintenance of all existing vegetation to be retained and proposed vegetation. Site shall be attended at least weekly and as otherwise required. The following works shall be undertaken during the Maintenance Period.

(a) **Recurrent works** Undertake recurrent works throughout the Maintenance Period. These works shall include but are not limited to watering, weeding, fertilising, pest and disease control, returfing, staking and tying, replanting, cultivation, pruning, aerating, renovating, top dressing and the like.

(b) **Watering** Regularly water all plants and lawn areas to maintain optimal growing conditions. Contractor shall adjust the water quantity utilised with regard to climatic conditions prevalent at the time.

(c) **Replacements** Immediately replace plants which die or fail to thrive (at discretion of Landscape Architect) with plants of same species or variety and of same size and quality unless otherwise specified. Plant replacement shall be at Contractors expense, unless replacement is required due to vandalism or theft, which shall be determined by Landscape Architect. Required replacement of plants due to vandalism or theft shall be undertaken by Contractor and shall be paid for by Client at an agreed predetermined rate.

(d) **Mulched surfaces** Maintain mulched surfaces in clean, tidy, weed-free condition and shall reinstate mulch as necessary to maintain specified depths.

(e) **Stakes & ties** Adjust and/or replace stakes and ties as required. Remove stakes and ties at end of Maintenance Period if directed by Landscape Architect.

(f) **Lawn areas** Lawn areas shall be mown at regular intervals to ensure non heading of lawn with a fine-cutting mulching mower and clippings left on lawn to mulch and self-fertilise lawn areas. Primary cut after laying of lawn by others shall be determined on site taking into consideration season, watering and growth rate of lawn. Following the primary cut all lawns shall be regularly mown as required to ensure a healthy lawn and a neat appearance. Care shall always be taken to ensure that no clippings are left on surrounding roads or garden areas after mowing. Replace lawn areas that fail to thrive at discretion of Landscape Architect. All new and made good lawn areas shall be barricaded off from pedestrian traffic by use of star pickets and brightly coloured plastic safety mesh until establishment of lawn. Barricades shall be removed upon establishment of lawn area.

(g) **Weeding** Remove by hand, or by carefully supervised use of weedicide, any weed growth that may occur throughout Maintenance Period. This work shall be executed at weekly intervals so that all lawn and garden areas may be observed in a weed-free condition.

(h) **Pruning** Prune new and existing plants (excluding existing trees) as necessary to maintain dense foliage conditions. Any rogue branches, or branches overhanging or obstructing pathways, roads, doorways, etc., shall be removed by approved horticultural methods.

(i) **Spraying** Spraying for insect, fungal and disease attack shall be undertaken as required and in accordance with spray manufacturers recommendations at intervals taking into account the season of year during which landscape works are to be implemented.

(j) **Tree Care** Should any existing trees be damaged during construction works immediately engage an experienced arboriculturist and then undertake any rectification work recommended by arboriculturist.

Notes:
1. All dimensions and levels shall be verified by Contractor on site prior to commencement of work.
2. All detailing of drainage to paved areas shall be by others.
3. All levels shall be determined by others and approved on site by client.
4. Extent, height and position of all retaining walls shall be determined by others and approved on site by client.
5. Do not scale from drawings.
6. If in doubt contact the Landscape Architect.
7. All boundaries shall be surveyed prior to commencement of construction works.
8. This plan is for DA purposes only. It has not been detailed for construction.
9. All dimensions, levels and boundaries are nominal only.
10. This design shall not be copied, utilised or reproduced in any way without prior written permission of A Total Concept Landscape Architects.

DRAWING LANDSCAPE SPECIFICATION			
ADDRESS 29 DOBROYD ROAD, BAIGOWLAH		PROJECT # WOODHOUSE & DANK ARCHITECTS	
CLIENT WOODHOUSE & DANKS ARCHITECTS	DATE # 20/01/22	DWG # L/04	
	SCALE @ A3 N/A		
A Total Concept Landscape Architects & Swimming Pool Designers 65 West Street, North Sydney NSW 2060 Tel: (02) 9957 5122 Fx: (02) 9957 5922		DRAWN OC	
		CHKD JC	REVISION
		